

# SPS5000X Series wide range programmable Switching DC Power Supply datasheet

## Datasheet





















## Product Overview

The SPS5000X-Series is a programmable Switching DC Power supply series that provides a wide range of output power using single-channel and multi-channel output configurations coupled with constant power capability. The series of power supplies includes sixteen models with voltages to 160 VDC and power to 1080 W. The SPS5000X supplies can be connected in series (2 units) or in parallel (3 units) to meet the requirements of 0~320V and 0~270A, with a maximum combined power of 3240W.

The SPS5000X Series has a high brightness 2.4 inch OLED display, a user-friendly human-computer interface that enable easy control and performance monitoring. The SPS5000X provides high resolution voltage and current settings, adjustable slew rates, list sequence programming from the front panel or over the standard LAN/ USB interface, analog control, and over-voltage, current, power, and temperature protection. These features make the series an ideal choice for a variety of demanding markets, including Commercial Industrial, Education, Energy and Power Generation, laboratory general testing, the LED lighting industry, and automotive electronics.

## Main Features

-  Rated Output Voltage: 40V, 50V, 80V, 160V
-  Rated Output Power: 180W, 360W, 720W, 1080W
-  Wide range of output voltage and current, high efficiency power supply
-  CV, CC priority mode selection, better protection of equipment under test
-  Load transient recovery time (Load change from 50~100%) <1ms
-  Adjustable slew rate of output voltage and current
-  Setting and readback resolution: 1 mV, 1 mA
-  User enabled internal output discharge circuit to accelerate the down programming of the output voltage
-  Remote Voltage Sensing
-  List function up to 50 steps; can be created from the front panel or by importing list sequence files from a USB memory device
-  External analog voltage and resistor control of voltage or current output
-  External voltage and current monitoring output
-  OVP, OCP, LPP, OTP protection.
-  2.4-inch OLED high brightness liquid crystal display, 170-degree viewing angle
-  Standard Interface: USB, LAN, Analog Control Interface
-  Optional Interface: USB-GPIB module
-  1/2, 1/3, 1/6 rack mount size
-  Embedded Web Server offers remote control through a web browser without the need for the driver or software

## Design Features

### Constant Output Power

In constant output power mode, the voltage and current range is switched automatically to maximize the voltage and current without sacrificing the supply's output power. This mode enables the supply to provide a higher output voltage at lower current and a higher output current at lower voltage. Compared to the traditional rectangular output range of most supplies, the SPS5000X series power supply provides a wider voltage and current output range, which greatly increases the utilization of the power supply.

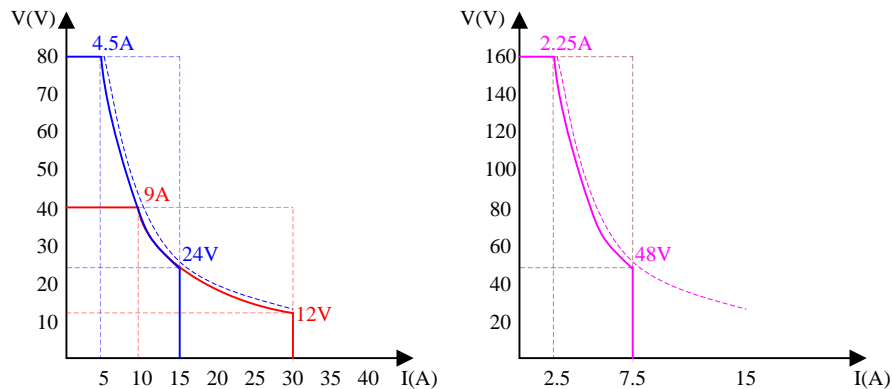

80V 15A/ 40V 30A Output Operating Area

160V 7.5A Output Operating Area

### Adjustable Output Voltage, Current up/down Slew Rate

The SPS5000X series supports custom setting of the rise/fall slew rate of voltage/current to verify the performance of the object under test as the voltage/current changes. This feature can effectively prevent the damage caused by inrush current to the DUT in applications such as the testing of capacitive current absorbing devices.

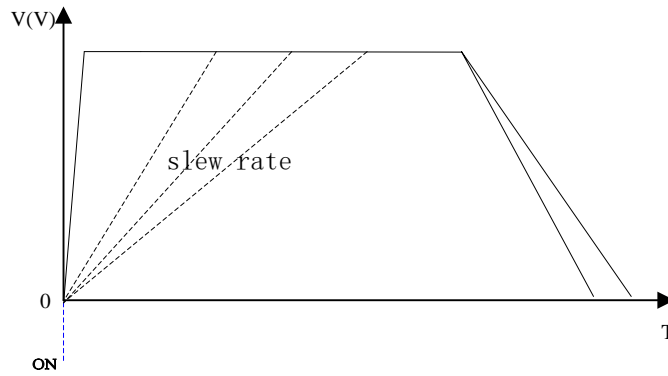

Output voltage, current up/down slew rate

### CV/CC Priority Mode

When the SPS5000X series power supply is set to CC priority mode, at the power output-on stage, it is able to operate under CC priority to limit the inrush current spike and overshoot voltage effectively when the power output is turned on.

In CV priority mode, the output voltage reaches the set voltage value quickly. In some applications, such as LED testing, when the power output is started, the surge current and overshoot voltage will appear when the voltage reaches the on-state voltage of the LEDs.



CV priority mode



CC priority mode

## Adjustable Output Resistance

The SPS5000X series power supply supports software - defined settings for output internal resistance. It can be used as an internal resistance in series with the positive output pole. At this point, the power supply is equivalent to the power supply containing internal resistance, such as lead-acid battery or lithium battery.

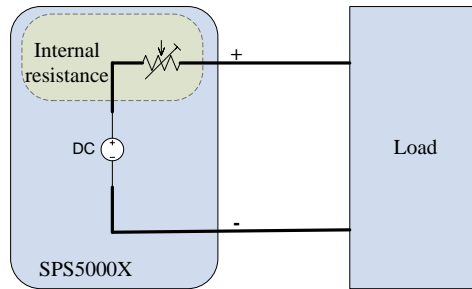

Internal resistance setting

## Built-in Discharge Circuit

SPS5000X series power supply is designed with a discharge circuit in parallel with the output terminal, which can be equivalent to a parallel resistance. When the power is turned off and the load is disconnected, the discharge circuit will discharge the power in the output filter capacitor. Without the discharge circuit, the output capacitance will remain charged, which may pose a dangerous voltage at the output terminals for a period of time. The discharge circuit can also be used to adjust the voltage down slew rate. This function is enabled in the menu by the user.

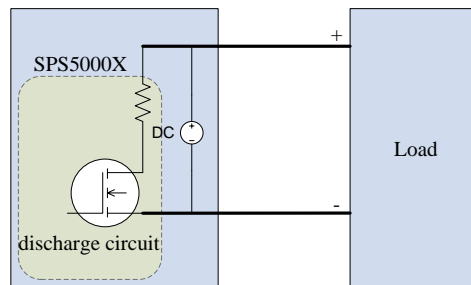

Discharge circuit

## Intuitive List Operation Function

By editing the single-step setting value, duration, and slew rate, the List function can generate multiple complex sequences to meet complex test requirements. The user can edit the sequence by 50 steps natively or import the List sequence file via USB for multi-step running.

The minimum precision of delay time is 1ms. The minimum running time is 1 second.

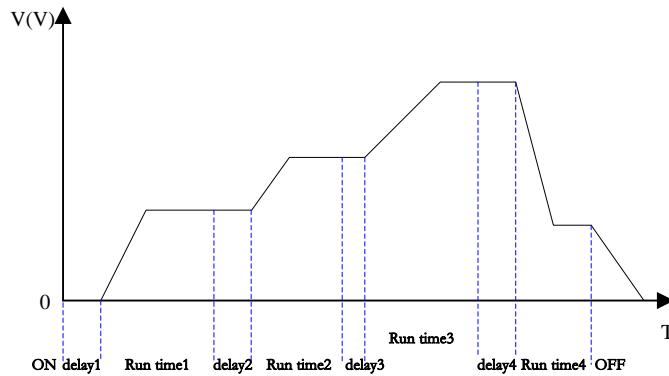

List mode

## External Analog Control

Four operating modes can be implemented using the analog port on the back of the unit; voltage-controlled voltage, voltage-controlled current, resistance-controlled voltage, and resistance-controlled current. In external voltage control mode, when the terminal is connected with adjustable voltage of 0-10V, it can be used to adjust the output from 0 to full range (10V corresponds to the voltage or current value of the full range of the power supply).

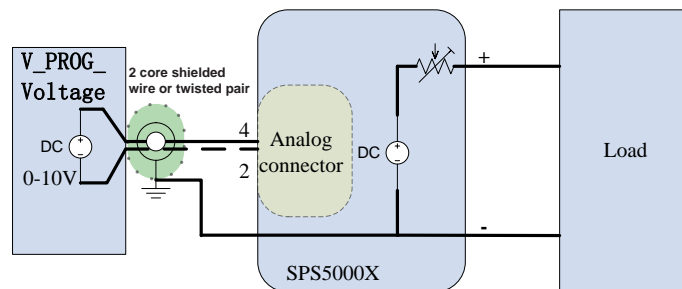

External voltage programming voltage output

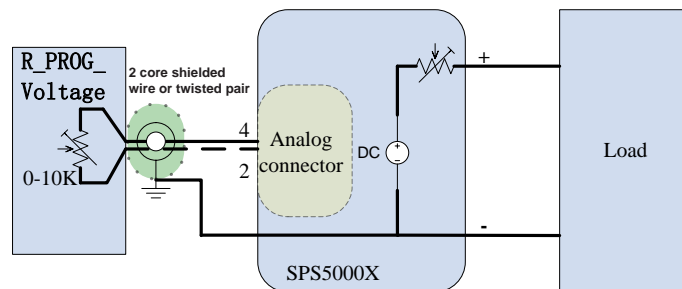

External resistance programming voltage output

### Voltage, Current Monitor Output

The voltage and current output monitoring terminal output is a 0-10V voltage analog signal with the corresponding value representing the output current or voltage of the power supply from 0 to full range. The user can connect to one of Siglent's DMMs or oscilloscopes to display the output current or voltage changes.

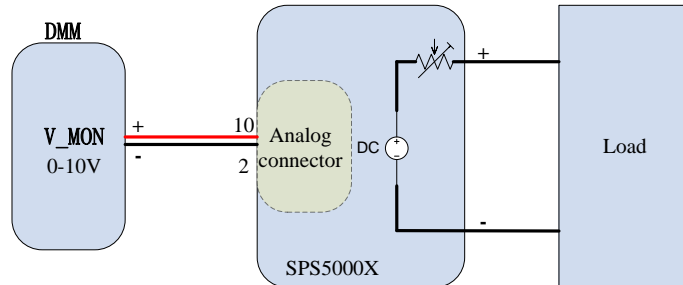

External DMM Monitoring of the Output Voltage

### Series and Parallel Function

Multiple single-channel SPS5000X series modules can be connected in series (2 units max.) or in parallel (3 units max), to increase the total output voltage, current and power. The SPS5000X series offers a highly flexible configuration concept to provide high power density that meets the needs of many applications.

(Typically, outputs of the supply float so the negative terminals are not connected to chassis ground. The negative terminals can also be connected to chassis ground.)

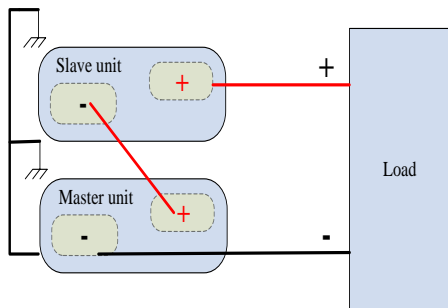

Series Connection

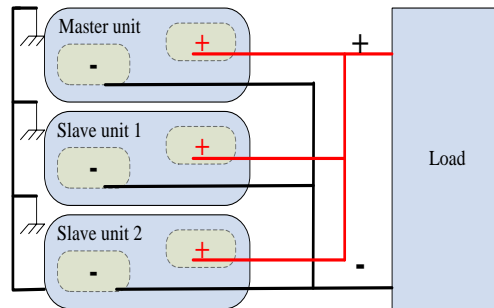

Parallel Connection

SPS5000X dual-channel model supports two-channel serial and parallel mode to increase voltage or current output.

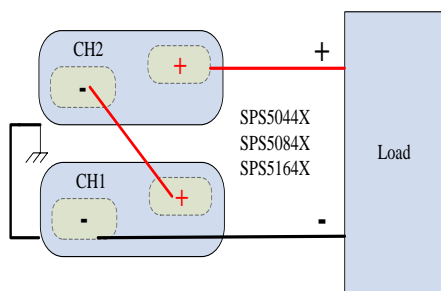

Dual-channel Series Connection

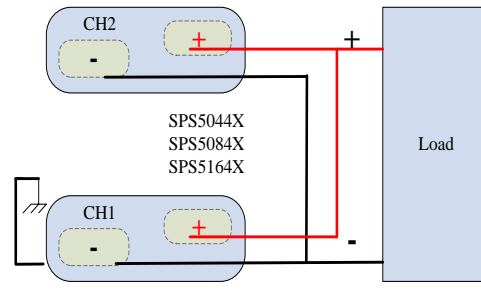

Dual-channel Parallel Connection



SPS5000X three-channel model supports the combination of CH1,CH2 channel series and parallel mode and CH1,CH2,CH3 parallel mode for increased voltage or current output.

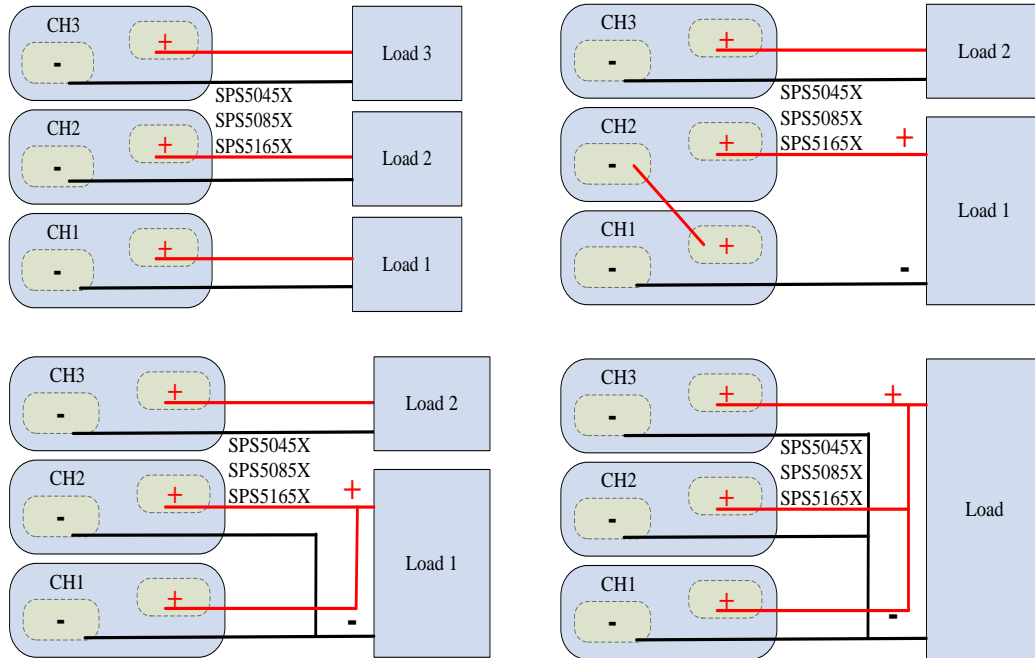

SPS5000X three-channel model

## Output ON/OFF delay

Using the power output delay function, the output the output power up and power down of multiple supplies can be precisely set relative to each other. The delay can be set using analog control or programmed through the USB or Ethernet ports.

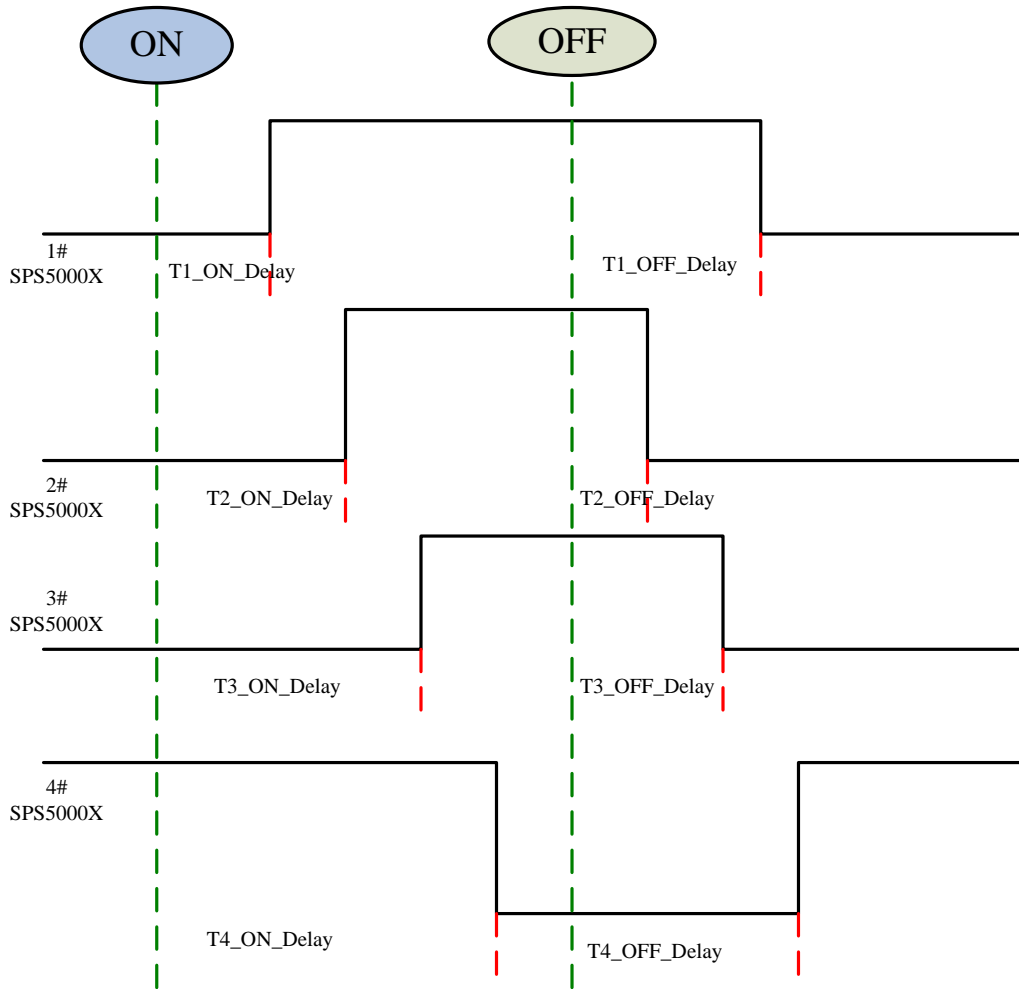

Multiple SPS5000X output delay control examples

SPS5000X power supply 2 channel output, 3 channel output machine internal configuration output 2 or 3 channel up and down power sequence function.



SPS5085X 3 channel List delay control output.

## Multiple Policy Protection Patterns

The protection functions of the power supply include over current protection (OCP), over voltage protection (OVP) and over temperature protection (OTP). If protection occurs, the power supply will turn off the output and enter protection mode. Protection can be released by pressing the Esc key for at least 2 seconds. Upon entering the Limited power protection (LPP), the system will start the power limitation mode, the maximum output power is about 105% of the rated power

## Save/Recall Setting Parameters

The power supply allows users to save multiple types of files to memory for later recall. The power supply provides a non-volatile internal memory and an external memory via the USB port with a user provided USB memory device.

## Rich Interface

The power supply includes USB and Ethernet communication interfaces as standard, and a

USB-GPIB converter module as optional. The embedded Web Server enables control and monitor of the power supply directly from a web browser, eliminating the need to install software drivers or applications.

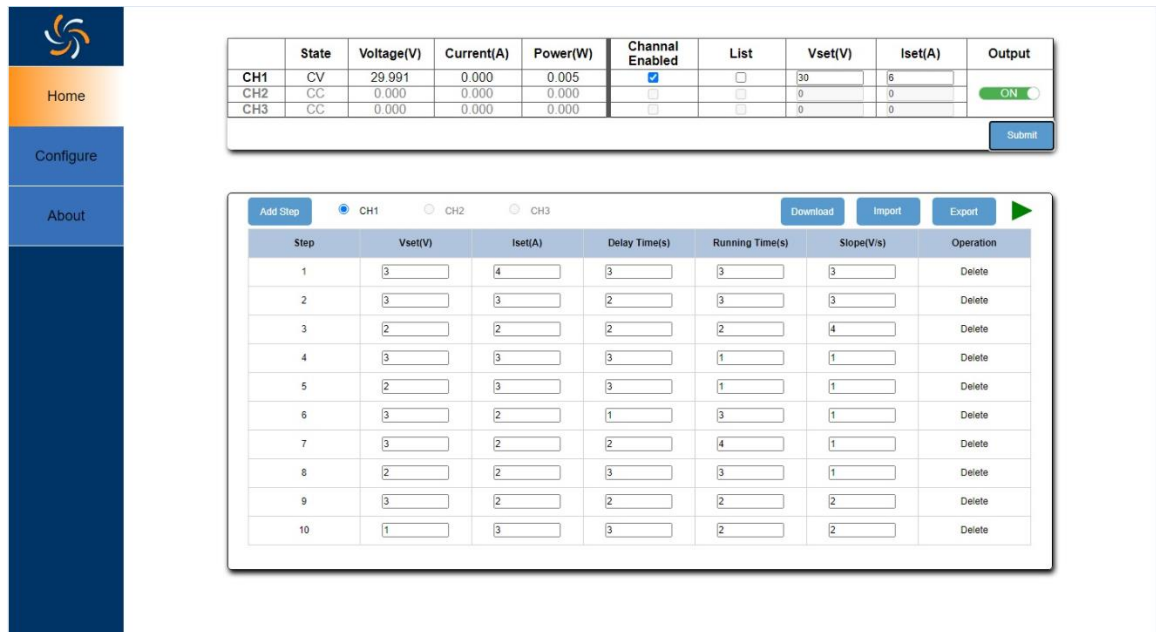

The screenshot displays the web server interface for the power supply. On the left is a navigation menu with 'Home', 'Configure', and 'About' options. The main area is divided into two sections:

**Channel Status Table:**

|     | State | Voltage(V) | Current(A) | Power(W) | Channel Enabled                     | List                     | Vset(V) | Iset(A) | Output                   |
|-----|-------|------------|------------|----------|-------------------------------------|--------------------------|---------|---------|--------------------------|
| CH1 | CV    | 29.991     | 0.000      | 0.005    | <input checked="" type="checkbox"/> | <input type="checkbox"/> | 30      | 6       | <input type="checkbox"/> |
| CH2 | CC    | 0.000      | 0.000      | 0.000    | <input type="checkbox"/>            | <input type="checkbox"/> | 0       | 0       | <input type="checkbox"/> |
| CH3 | CC    | 0.000      | 0.000      | 0.000    | <input type="checkbox"/>            | <input type="checkbox"/> | 0       | 0       | <input type="checkbox"/> |

**Sequence Programming Table:**

Buttons: Add Step, CH1 (selected), CH2, CH3, Download, Import, Export

| Step | Vset(V) | Iset(A) | Delay Time(s) | Running Time(s) | Slope(V/s) | Operation |
|------|---------|---------|---------------|-----------------|------------|-----------|
| 1    | 3       | 4       | 3             | 3               | 3          | Delete    |
| 2    | 3       | 3       | 2             | 3               | 3          | Delete    |
| 3    | 2       | 2       | 2             | 2               | 4          | Delete    |
| 4    | 3       | 3       | 3             | 1               | 1          | Delete    |
| 5    | 2       | 3       | 3             | 1               | 1          | Delete    |
| 6    | 3       | 2       | 1             | 3               | 1          | Delete    |
| 7    | 3       | 2       | 2             | 4               | 1          | Delete    |
| 8    | 2       | 2       | 3             | 3               | 1          | Delete    |
| 9    | 3       | 2       | 2             | 2               | 2          | Delete    |
| 10   | 1       | 3       | 3             | 2               | 2          | Delete    |

**Web Server Interface**

## Specifications

Unless otherwise noted, all specifications are guaranteed within the temperature range of 25°C ± 5 °C with warm-up time of 30 minutes.

| Model                                     | SPS5041X   | SPS5042X | SPS5043X | SPS5044X | SPS5045X | units  |
|---|--|----------|----------|----------|----------|--------|
| Output channel                            | 1  |          |          | 2        | 3        | CH     |
| Rated output voltage                      | 40   |          |          |          |          | V      |
| Rated output current                      | 30   | 60       | 90       | 30       |          | A      |
| Total rated output power                  | 360  | 720      | 1080     | 720      | 1080     | W      |
| Power Ratio                               | 3.33   |          |          |          |          |        |
| <b>C.V Mode</b>                           |  |          |          |          |          |        |
| Line Regulation                           | 18 (From 90 ~ 132Vac or 170 ~ 265Vac, constant load)   |          |          |          |          | mV     |
| Load Regulation                           | 20 (From No load to Full load, constant input voltage)   |          |          |          |          | mV     |
| Ripple and Noise (*1)                     | (Noise Bandwidth 20MHz; Ripple Bandwidth 1MHz)   |          |          |          |          |        |
| RIPPLE(pk to pk)                          | 60   | 80       | 100      | 60       |          | mV     |
| RMS RIPPLE                                | 7  | 11       | 14       | 7        |          | mV     |
| Voltage programming Accuracy              | 0.1%±10  |          |          |          |          | mV     |
| Voltage programming resolution            | 1  |          |          |          |          | mV     |
| Voltage Readback Accuracy                 | 0.1%±20  |          |          |          |          | mV     |
| Voltage Readback resolution               | 1  |          |          |          |          | mV     |
| Temperature coefficient                   | 100ppm/°C from rated output voltage following 30-minute warm-up.                               |          |          |          |          | ppm/°C |
| Remote compensation voltage (single wire) | 0.6  |          |          |          |          | V      |
| Rise Time                                 | 10% ~ 90% of rated output voltage, rated resistance load                                       |          |          |          |          |        |
| Rated Load                                | 50   |          |          |          |          | ms     |
| No Load                                   | 50   |          |          |          |          | ms     |
| Fall Time                                 | 90% ~ 10% of rated output voltage, rated resistance load                                       |          |          |          |          |        |
| Rated Load                                | 50   |          |          |          |          | ms     |
| No Load                                   | 500  |          |          |          |          | ms     |
| Transient response time                   | 1 (Time for recovery to within 0.1% + 10mV of its rated output against current of 50% ~ 100%.) |          |          |          |          | ms     |
| <b>C.C Mode</b>                           |  |          |          |          |          |        |
| Line Regulation                           | 40   | 75       | 110      | 40       |          | mA     |
| Load Regulation                           | 40   | 75       | 110      | 40       |          | mA     |
| Ripple and Noise                          |  |          |          |          |          |        |
| r.m.s                                     | 72   | 144      | 216      | 72       |          | mA     |

|   |   |             |             |            |        |
|---|---|-------------|-------------|------------|--------|
| Current Setting Accuracy  | 0.1%±30   | 0.1%±60     | 0.1%±100    | 0.1%±30    | mA     |
| Current programming resolution  | 1   |             |             |            | mA     |
| Current Readback Accuracy   | 0.1%±40   | 0.1%±70     | 0.1%±100    | 0.1%±40    | mA     |
| Current Readback resolution   | 1   |             |             |            | mA     |
| Temperature coefficient   | 200ppm/°C from rated output current following 30-minute warm-up.      |             |             |            | ppm/°C |
| <b>Protection Function</b>  |   |             |             |            |        |
| OVP   |   |             |             |            |        |
| Setting Range   | 4~44  |             |             |            | V      |
| Setting Accuracy  | ± (2% of rated output voltage)  |             |             |            |        |
| OCP   | The maximum output current limit of the front output terminal is 10A. |             |             |            |        |
| Setting Range   | 3~30  | 6~60        | 9~90        | 3~30       | A      |
| Setting Accuracy  | ± (2% of rated output current)  |             |             |            |        |
| OTP   | Over temperature alarm and shut off output.                           |             |             |            |        |
| Low AC Input Protection   | Shut off output.  |             |             |            |        |
| LPP   | The over power limit is approximately 105% of the rated output power. |             |             |            |        |
| <b>Rising/Falling Voltage Slew Rate: Only applicable if V-I Mode is set to CV Slew Rate Priority.</b> |   |             |             |            |        |
|   | 0.1~80  |             |             |            | V/s    |
| <b>Rising/Falling Current Slew Rate: Only applicable if V-I Mode is set to CC Slew Rate Priority.</b> |   |             |             |            |        |
|   | 0.01~60.00  | 0.01~120.00 | 0.01~180.00 | 0.01~60.00 | A/s    |
| <b>Output resistance setting</b>  |   |             |             |            |        |
|   | 0~1.5   | 0~0.75      | 0~0.5       | 0~1.5      | Ω      |
| <b>Efficiency</b>   |   |             |             |            |        |
| 100Vac  | >77   |             |             |            | %      |
| 200Vac  | >79   |             |             |            | %      |

| Model                                     | SPS5051X   | SPS5081X   | SPS5082X | SPS5083X | SPS5084X | SPS5085X | units  |
|---|--|--|----------|----------|----------|----------|--------|
| Output channel                            | 1  | 1  |          |          | 2        | 3        | CH     |
| Rated output voltage                      | 50   | 80   |          |          |          |          | V      |
| Rated output current                      | 10   | 15   | 30       | 45       | 15       |          | A      |
| Total rated output power                  | 180  | 360  | 720      | 1080     | 720      | 1080     | W      |
| Power Ratio                               | <b>2.77</b>  | <b>3.33</b>  |          |          |          |          |        |
| <b>C.V Mode</b>                           |  |  |          |          |          |          |        |
| Line Regulation                           | 3  | 40 (From 90 ~ 132Vac or 170 ~ 265Vac, constant load)   |          |          |          |          | mV     |
| Load Regulation                           | 10   | 40 (From No load to Full load, constant input voltage) |          |          |          |          | mV     |
| Ripple and Noise (*1)                     | (Noise Bandwidth 20MHz; Ripple Bandwidth 1MHz)   |  |          |          |          |          |        |
| RIPPLE(pk to pk)                          | 45   | 60   | 80       | 100      | 60       |          | mV     |
| RMS RIPPLE                                | 4  | 7  | 11       | 14       | 7        |          | mV     |
| Voltage programming Accuracy              | 0.1%±10  |  |          |          |          |          | mV     |
| Voltage programming resolution            | 1  |  |          |          |          |          | mV     |
| Voltage Readback Accuracy                 | 0.1%±20  |  |          |          |          |          | mV     |
| Voltage Readback resolution               | 1  |  |          |          |          |          | mV     |
| Temperature coefficient                   | 100ppm/°C from rated output voltage following 30-minute warm-up.                               |  |          |          |          |          | ppm/°C |
| Remote compensation voltage (single wire) | 0.6  |  |          |          |          |          | V      |
| Rise Time                                 | 10% ~ 90% of rated output voltage, rated resistance load                                       |  |          |          |          |          |        |
| Rated Load                                | 50   |  |          |          |          |          | ms     |
| No Load                                   | 50   |  |          |          |          |          | ms     |
| Fall Time                                 | 90% ~ 10% of rated output voltage, rated resistance load                                       |  |          |          |          |          |        |
| Rated Load                                | 50   |  |          |          |          |          | ms     |
| No Load                                   | 500  |  |          |          |          |          | ms     |
| Transient response time                   | 1 (Time for recovery to within 0.1% + 10mV of its rated output against current of 50% ~ 100%.) |  |          |          |          |          | ms     |
| <b>C.C Mode</b>                           |  |  |          |          |          |          |        |
| Line Regulation                           | 8  | 18   | 32       | 45       | 18       |          | mA     |
| Load Regulation                           | 10   | 18   | 32       | 45       | 18       |          | mA     |
| Ripple and Noise                          |  |  |          |          |          |          |        |
| r.m.s                                     | 10   | 27   | 54       | 81       | 27       |          | mA     |
| Current Setting Accuracy                  | 0.1%±10  | 0.1%±10  | 0.1%±30  | 0.1%±40  | 0.1%±10  |          | mA     |
| Current programming resolution            | 1  |  |          |          |          |          | mA     |

|   |   |            |            |            |            |        |
|---|---|------------|------------|------------|------------|--------|
| Current Readback Accuracy   | 0.1%±20   | 0.1%±20    | 0.1%±40    | 0.1%±50    | 0.1%±20    | mA     |
| Current Readback resolution   | 1   |            |            |            |            | mA     |
| Temperature coefficient   | 200ppm/°C from rated output current following 30-minute warm-up.      |            |            |            |            | ppm/°C |
| <b>Protection Function</b>  |   |            |            |            |            |        |
| OVP   |   |            |            |            |            |        |
| Setting Range   | 5~55  | 8~88       |            |            |            | V      |
| Setting Accuracy  | ± (2% of rated output voltage)  |            |            |            |            |        |
| OCP   | The maximum output current limit of the front output terminal is 10A. |            |            |            |            |        |
| Setting Range   | 1~11  | 1.5~16.5   | 3~33       | 4.5~49.5   | 1.5~16.5   | A      |
| Setting Accuracy  | ± (2% of rated output current)  |            |            |            |            |        |
| OTP   | Over temperature alarm and shut off output.                           |            |            |            |            |        |
| Low AC Input Protection   | Shut off output.  |            |            |            |            |        |
| LPP   | The over power limit is approximately 105% of the rated output power. |            |            |            |            |        |
| <b>Rising/Falling Voltage Slew Rate: Only applicable if V-I Mode is set to CV Slew Rate Priority.</b> |   |            |            |            |            |        |
|   | 0.1~100   | 0.1~160    |            |            |            | V/s    |
| <b>Rising/Falling Current Slew Rate: Only applicable if V-I Mode is set to CC Slew Rate Priority.</b> |   |            |            |            |            |        |
|   | 0.01~20.00  | 0.01~30.00 | 0.01~60.00 | 0.01~90.00 | 0.01~30.00 | A/s    |
| <b>Output resistance setting</b>  |   |            |            |            |            |        |
|   | 0~6   | 0~6        | 0~3        | 0~2        | 0~6        | Ω      |
| <b>Efficiency</b>   |   |            |            |            |            |        |
| 100Vac  | >77   | >77        |            |            |            | %      |
| 200Vac  | >79   | >79        |            |            |            | %      |



| Model                                     | SPS5161X   | SPS5162X | SPS5163X | SPS5164X | SPS5165X | units  |
|---|--|----------|----------|----------|----------|--------|
| Output channel                            | 1  |          |          | 2        | 3        | CH     |
| Rated output voltage                      | 160  |          |          |          |          | V      |
| Rated output current                      | 7.5  | 15       | 22.5     | 7.5      |          | A      |
| Total rated output power                  | 360  | 720      | 1080     | 720      | 1080     | W      |
| Power Ratio                               | 3.33   |          |          |          |          |        |
| <b>C.V Mode</b>                           |  |          |          |          |          |        |
| Line Regulation                           | 80 (From 90 ~ 132Vac or 170 ~ 265Vac, constant load)   |          |          |          |          | mV     |
| Load Regulation                           | 80 (From No load to Full load, constant input voltage)   |          |          |          |          | mV     |
| Ripple and Noise (*1)                     | (Noise Bandwidth 20MHz; Ripple Bandwidth 1MHz)   |          |          |          |          |        |
| RIPPLE(pk to pk)                          | 60   | 80       | 100      | 60       |          | mV     |
| RMS RIPPLE                                | 12   | 15       | 20       | 12       |          | mV     |
| Voltage programming Accuracy              | 0.1%±100   |          |          |          |          | mV     |
| Voltage programming resolution            | 1  |          |          |          |          | mV     |
| Voltage Readback Accuracy                 | 0.1%±100   |          |          |          |          | mV     |
| Voltage Readback resolution               | 1  |          |          |          |          | mV     |
| Temperature coefficient                   | 100ppm/°C from rated output voltage following 30-minute warm-up.                               |          |          |          |          | ppm/°C |
| Remote compensation voltage (single wire) | 0.6  |          |          |          |          | V      |
| Rise Time                                 | 10% ~ 90% of rated output voltage, rated resistance load                                       |          |          |          |          |        |
| Rated Load                                | 100  |          |          |          |          | ms     |
| No Load                                   | 100  |          |          |          |          | ms     |
| Fall Time                                 | 90% ~ 10% of rated output voltage, rated resistance load                                       |          |          |          |          |        |
| Rated Load                                | 100  |          |          |          |          | ms     |
| No Load                                   | 1000   |          |          |          |          | ms     |
| Transient response time                   | 2 (Time for recovery to within 0.1% + 10mV of its rated output against current of 50% ~ 100%.) |          |          |          |          | ms     |
| <b>C.C Mode</b>                           |  |          |          |          |          |        |
| Line Regulation                           | 12   | 19       | 26       | 12       |          | mA     |
| Load Regulation                           | 12   | 19       | 26       | 12       |          | mA     |
| Ripple and Noise                          |  |          |          |          |          |        |
| r.m.s                                     | 15   | 30       | 45       | 15       |          | mA     |
| Current Setting Accuracy                  | 0.1%±5   | 0.1%±15  | 0.1%±20  | 0.1%±5   |          | mA     |
| Current programming resolution            | 1  |          |          |          |          | mA     |
| Current Readback Accuracy                 | 0.1%±5   | 0.1%±15  | 0.1%±20  | 0.1%±5   |          | mA     |
| Current Readback resolution               | 1  |          |          |          |          | mA     |
| Temperature coefficient                   | 200ppm/°C from rated output current following 30-minute warm-up.                               |          |          |          |          | ppm/°C |
| <b>Protection Function</b>                |  |          |          |          |          |        |

|   |   |            |            |            |     |
|---|---|------------|------------|------------|-----|
| OVP   |   |            |            |            |     |
| Setting Range   | 16~176  |            |            |            | V   |
| Setting Accuracy  | ± (2% of rated output voltage)  |            |            |            |     |
| OCP   | The maximum output current limit of the front output terminal is 10A. |            |            |            |     |
| Setting Range   | 0.75~8.25   | 1.5~16.5   | 2.25~24.75 | 0.75~8.25  | A   |
| Setting Accuracy  | ± (2% of rated output current)  |            |            |            |     |
| OTP   | Over temperature alarm and shut off output.                           |            |            |            |     |
| Low AC Input Protection   | Shut off output.  |            |            |            |     |
| LPP   | The over power limit is approximately 105% of the rated output power. |            |            |            |     |
| <b>Rising/Falling Voltage Slew Rate: Only applicable if V-I Mode is set to CV Slew Rate Priority.</b> |   |            |            |            |     |
|   | 0.1~320   |            |            |            | V/s |
| <b>Rising/Falling Current Slew Rate: Only applicable if V-I Mode is set to CC Slew Rate Priority.</b> |   |            |            |            |     |
|   | 0.01~15.00  | 0.01~30.00 | 0.01~45.00 | 0.01~15.00 | A/s |
| <b>Output resistance setting</b>  |   |            |            |            |     |
|   | 0~24  | 0~12       | 0~8        | 0~24       | Ω   |
| <b>Efficiency</b>   |   |            |            |            |     |
| 100Vac  | >80   |            |            |            | %   |
| 200Vac  | >82   |            |            |            | %   |

**\*1: Use probe to measure at the positive and negative poles of sense terminal.**

|   | 1-channel   |       |       |       | 2-channel                            | 3-channel |       |
|---|---|-------|-------|-------|--------------------------------------|-----------|-------|
| <b>Series and parallel capability</b>             |   |       |       |       |                                      |           |       |
| parallel  | 3   |       |       |       | none                                 |           | Units |
| Series  | 2   |       |       |       | none                                 |           | Units |
| Channels in series and parallel                   | none  |       |       |       | Connect through an analog interface. |           |       |
| <b>Analog programming and monitoring</b>          |   |       |       |       |                                      |           |       |
| External Voltage Control of the Voltage Output    | Accuracy: +0.5% of rated output voltage   |       |       |       |                                      |           |       |
| External Voltage Control of the Current Output    | Accuracy: +1% of rated output current   |       |       |       |                                      |           |       |
| External Resistance Control of the Voltage Output | Accuracy: +1.5% of rated output voltage   |       |       |       |                                      |           |       |
| External Resistance Control of the Current Output | Accuracy: +1.5% of rated output current   |       |       |       |                                      |           |       |
| Output Voltage/ Current monitor accuracy          | ±1  |       |       |       |                                      |           | %     |
| Shutdown control                                  | Close output with LOW (0V~0.5V) or short circuit  |       |       |       |                                      |           |       |
| Output On/Off control                             | Use LOW (0V~0.5V) or short circuit to turn on the output.<br>Use HIGH (4.5V~5V) or open circuit to turn off the output. |       |       |       |                                      |           |       |
| CV/CC/ERR/ ON/OFF Status                          | Photo coupler open collector output; Maximum voltage 30V, maximum sink current 8mA.                                     |       |       |       |                                      |           |       |
| <b>Input Characteristics</b>                      |   |       |       |       |                                      |           |       |
| Normal Rated Input                                | 100Vac ~ 240Vac, 50Hz ~ 60Hz, Single-phase  |       |       |       |                                      |           |       |
| Input Voltage Range                               | 90Vac ~ 265Vac  |       |       |       |                                      |           |       |
| Input Frequency Range                             | 47Hz ~ 63Hz   |       |       |       |                                      |           |       |
| Maximum Input Current of different power models   | 180W  | 360W  | 720W  | 1080W | 360W 2CH                             | 360W 3CH  |       |
| 100Vac  | 2.5   | 5     | 10    | 15    | 10                                   | 15        | A     |
| 200Vac  | 1.25  | 2.5   | 5     | 7.5   | 5                                    | 7.5       | A     |
| Surge Current                                     | <15A.   | <25A. | <50A. | <75A. | <50A.                                | <75A.     |       |
| Maximum Input Power                               | 250   | 500   | 1000  | 1500  | 1000                                 | 1500      | VA    |
| Power factor                                      |   |       |       |       |                                      |           |       |
| 100Vac  | 0.99  |       |       |       |                                      |           |       |
| 200Vac  | 0.98  |       |       |       |                                      |           |       |
| Hold-up time                                      | ≥20ms   |       |       |       |                                      |           |       |
| <b>Interface capability</b>                       |   |       |       |       |                                      |           |       |
| USB   | Type A: HOST, Type B: DEVICE, SPEED: 1.1/2.0  |       |       |       |                                      |           |       |
| LAN   | MAC address, Gateway IP address, Instrument IP address, Subnet Mask   |       |       |       |                                      |           |       |
| GPIB  | Optional: USB-GPIB adapter  |       |       |       |                                      |           |       |

| Environment Condition  |  |             |             |             |             |    |
|------------------------|--|-------------|-------------|-------------|-------------|----|
| Operating Temperature  | 0°C ~ 50°C   |             |             |             |             |    |
| Storage temperature    | -25°C ~ 70°C   |             |             |             |             |    |
| Operating humidity     | 20% ~ 85% RH; No condensation  |             |             |             |             |    |
| Storage humidity       | 90% RH or less; No condensation  |             |             |             |             |    |
| Altitude               | ≤ 2000m  |             |             |             |             |    |
| General specifications |  |             |             |             |             |    |
| Weight (host only)     | 3.3  | 5.3         | 7.5         | 5.5         | 7.8         | Kg |
| Dimensions (WxHxD)     | 71x124x418   | 142x124x418 | 214x124x418 | 142x124x418 | 214x124x418 | mm |
| Cooling                | Internal fan forced air cooling  |             |             |             |             |    |
| EMC                    | Class A test and measurement products in compliance with European EMC Directive 2014/30/EU |             |             |             |             |    |
| Withstand Voltage      | Input to Base: 1500 VAC for 1 minute without abnormality                                   |             |             |             |             |    |
|                        | Input to Output: 3000 VAC for 1 minute without abnormality                                 |             |             |             |             |    |
|                        | Output to Base: 500 VDC for 1 minute without abnormality                                   |             |             |             |             |    |
| Insulation Resistance  | Input to Base: 500 VDC, ≥100m Ω  |             |             |             |             |    |
|                        | Input and Output: 500 VDC, ≥ 100m Ω  |             |             |             |             |    |
|                        | Output to Base: 500 VDC, ≥100m Ω   |             |             |             |             |    |

## Ordering information

| Product information        |   | Product No |
|----------------------------|---|------------|
| 40V/30A 360W               | Single channel programmable Switching DC Power supply | SPS5041X   |
| 40V/60A 720W               | Single channel programmable Switching DC Power supply | SPS5042X   |
| 40V/90A 1080W              | Single channel programmable Switching DC Power supply | SPS5043X   |
| 40V/30A 360WX2             | Dual Channel Programmable Switching DC Power supply   | SPS5044X   |
| 40V/30A 360WX3             | Three Channel Programmable Switching DC Power supply  | SPS5045X   |
| 50V/10A 180W               | Single channel programmable Switching DC Power supply | SPS5051X   |
| 80V/15A 360W               | Single channel programmable Switching DC Power supply | SPS5081X   |
| 80V/30A 720W               | Single channel programmable Switching DC Power supply | SPS5082X   |
| 80V/45A 1080W              | Single channel programmable Switching DC Power supply | SPS5083X   |
| 80V/15A 360WX2             | Dual Channel Programmable Switching DC Power supply   | SPS5084X   |
| 80V/15A 360WX3             | Three Channel Programmable Switching DC Power supply  | SPS5085X   |
| 160V/7.5A 360W             | Single channel programmable Switching DC Power supply | SPS5161X   |
| 160V/15A 720W              | Single channel programmable Switching DC Power supply | SPS5162X   |
| 160V/22.5A 1080W           | Single channel programmable Switching DC Power supply | SPS5163X   |
| 160V/7.5A 360WX2           | Dual Channel Programmable Switching DC Power supply   | SPS5164X   |
| 160V/7.5A 360WX3           | Three Channel Programmable Switching DC Power supply  | SPS5165X   |
| Standard Accessories       |   |            |
| USB Cable -1               |   |            |
| Quick Start -1             |   |            |
| Calibration Certificate -1 |   |            |
| Power Cord -1              |   |            |
| Output guard -1            |   |            |

## Warranty

Three-year warranty, excluding accessories.

## About SIGLENT

SIGLENT is an international high-tech company, concentrating on R&D, sales, production and services of electronic test & measurement instruments.

SIGLENT first began developing digital oscilloscopes independently in 2002. After more than a decade of continuous development, SIGLENT has extended its product line to include digital oscilloscopes, isolated handheld oscilloscopes, function/arbitrary waveform generators, RF/MW signal generators, spectrum analyzers, vector network analyzers, digital multimeters, DC power supplies, electronic loads and other general purpose test instrumentation. Since its first oscilloscope was launched in 2005, SIGLENT has become the fastest growing manufacturer of digital oscilloscopes. We firmly believe that today SIGLENT is the best value in electronic test & measurement.

### Headquarters:

SIGLENT Technologies Co., Ltd  
Add: Bldg No.4 & No.5, Antongda Industrial  
Zone, 3rd Liuxian Road, Bao'an District,  
Shenzhen, 518101, China  
Tel: + 86 755 3688 7876  
Fax: + 86 755 3359 1582  
Email: sales@siglent.com  
Website: int.siglent.com

### USA:

SIGLENT Technologies America, Inc  
6557 Cochran Rd Solon, Ohio 44139  
Tel: 440-398-5800  
Toll Free: 877-515-5551  
Fax: 440-399-1211  
Email: info@siglent.com  
Website: www.siglentna.com

### Europe:

SIGLENT Technologies Germany GmbH  
Add: Staetzlinger Str. 70  
86165 Augsburg, Germany  
Tel: +49(0)-821-666 0 111 0  
Fax: +49(0)-821-666 0 111 22  
Email: info-eu@siglent.com  
Website: www.siglenteu.com

Follow us on  
Facebook: SiglentTech

