

SNA-TB01

RF Demonstration Board

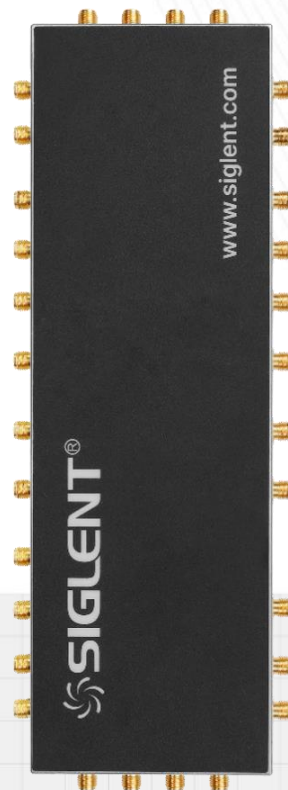
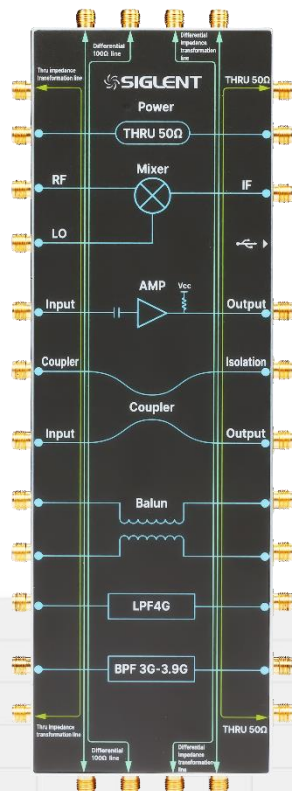

SIGLENT TECHNOLOGIES CO.,LTD

Copyright and Declaration

Copyright

SIGLENT TECHNOLOGIES CO., LTD. All Rights Reserved.

Trademark Information

SIGLENT is the registered trademark of SIGLENT TECHNOLOGIES CO., LTD.

Declaration

- **SIGLENT** products are protected by patent law in and outside of P.R.C.
- **SIGLENT** reserves the right to modify or change parts of or all the specifications or pricing policies at company's sole decision.
- Information in this publication replaces all previously corresponding material.
- Any way of copying, extracting or translating the contents of this manual is not allowed without the permission of **SIGLENT**.

Product Certification

SIGLENT guarantees this product conforms to the national and industrial stands in China and other international stands conformance certification is in progress.

Contact Us

If you have any problem or requirement when using our products, please contact **SIGLENT TECHNOLOGIES CO., LTD**

Add : Blog No.4 & No.5, Antongda Industrial Zone, 3rd Liuxian Road, Bao'an District, Shenzhen, 518101, China

Tel : 400-878-0807

E-mail : sales@siglent.com

<http://www.siglent.com>

Contents

1	Important Safety Information	3
1.1	General Safety Summary	3
1.2	Safety Terms and Symbols	4
1.3	Maintenance and Cleaning	4
	Informations	5
	Exigence de Sécurité	5
	Termes et symboles de sécurité	6
	Entretien et nettoyage.....	6
2	Product Introduction	7
2.1	Dimension.....	8
2.2	Front panel.....	9
2.3	Rear panel.....	10
3	Module Introduction and Testing Indicators	11
3.1	50 Ω Short Through Line	11
3.2	Mixer	11
3.3	Amplifier	13
3.4	Coupler	15
3.5	Balun	16
3.6	Filter	17
3.7	Long Through Line and Impedance Transformation Line	18
3.8	Differential Line and Differential Impedance Transformation Line	19
4	Test Guide	20
4.1	Document Conventions.....	20
4.2	Prepare before Testing	20
	4.2.1 Testing Instrument and Tool	20
	4.2.2 Instrument Setup and Calibration	21
4.3	Test Step	22
	4.3.1 50 Ω Short Through Line	22
	4.3.2 Mixer	22
	4.3.3 Amplifier	24
	4.3.4 Coupler	28
	4.3.5 Balun	29
	4.3.6 Filter	30
	4.3.7 Long Through Line and Impedance Transformation Line	32
	4.3.8 Differential Line and Differential Impedance Transformation Line	35

1 Important Safety Information

This manual contains information and warnings that must be followed by the user for safe operation and to keep the product in a safe condition.

1.1 General Safety Summary

Carefully read the following safety precautions to avoid personal injury and prevent damage to the instrument and any products connected to it. To avoid potential hazards, please use the instrument as specified.

Only qualified technical personnel can carry out maintenance procedures.

To Avoid Fire or Personal Injury.

Look over All Terminals' Ratings.

To avoid fire or electric shock, please look over all ratings and signed instructions of the instrument. Before connecting the instrument, please read the manual carefully to gain more information about the ratings.

Equipment Maintenance and Service.

When the equipment fails, please do not dismantle the machine for maintenance. The equipment contains capacitors, power supply, transformers, and other energy storage devices, which may cause high voltage damage. The internal devices of the equipment are sensitive to static electricity, and direct contact is easy to cause irreparable damage to the equipment.

Avoid Circuit or Wire Exposed Components Exposed.

Do not touch exposed contacts or components when the power is on.

Do not operate in wet/damp conditions.

Do not operate in an explosive atmosphere.

Keep the surface of the instrument clean and dry.

1.2 Safety Terms and Symbols

When the following symbols or terms appear in this manual, they indicate special care in terms of safety.

	This symbol is used where caution is required. Refer to the accompanying information or documents to protect against personal injury or damage to the instrument.
---	---

1.3 Maintenance and Cleaning

Maintenance:

When storing or placing, do not expose this product to direct sunlight for an extended period of time.

Cleaning:

Clean only the exterior of the product, using a damp, soft cloth. Do not use chemicals or abrasive elements. Under no circumstances allow moisture to penetrate the product. To avoid electrical shock, unplug the power cord from the AC outlet before cleaning.

	CAUTION: To avoid damaging the product, do not use any corrosive or cleaning reagents, and do not place them in mist, liquids, or solvents. Before re powering on for use, please confirm that the product is dry to avoid electrical short circuits or even personal injury caused by moisture.
---	--

Informations

essentielles sur la sécurité

Ce manuel contient des informations et des avertissements que les utilisateurs doivent suivre pour assurer la sécurité des opérations et maintenir les produits en sécurité.

Exigence de Sécurité

Lisez attentivement les précautions de sécurité ci – après afin d'éviter les dommages corporels et de prévenir les dommages aux instruments et aux produits associés. Pour éviter les risques potentiels, utilisez les instruments prescrits.

Seul un technicien qualifié peut effectuer la procédure de réparation.

Éviter l'incendie ou les lésions corporelles.

Voir les cotes de tous les terminaux.

Pour éviter un incendie ou un choc électrique, vérifiez toutes les cotes et signez les instructions de l'instrument. Avant de brancher l'instrument, lisez attentivement ce manuel pour obtenir de plus amples renseignements sur les cotes.

Entretien du matériel.

En cas de défaillance de l'équipement, ne pas démonter et entretenir l'équipement sans autorisation. L'équipement contient des condensateurs, de l'alimentation électrique, des transformateurs et d'autres dispositifs de stockage d'énergie, ce qui peut causer des blessures à haute tension. Les dispositifs internes de l'équipement sont sensibles à l'électricité statique. Le contact direct peut facilement causer des blessures irréversibles à l'équipement.

L'exposition du circuit ou de l'élément d'exposition du fil est évitée.

Lorsque l'alimentation est connectée, aucun contact ou élément nu n'est mis en contact.

Ne pas fonctionner dans des conditions humides / humides.

Pas dans un environnement explosif.

Maintenez la surface de l'instrument propre et sec.

Termes et symboles de sécurité

Lorsque les symboles ou termes suivants apparaissent sur le panneau avant ou arrière de l'instrument ou dans ce manuel, ils indiquent un soin particulier en termes de sécurité.



Ce symbole est utilisé lorsque la prudence est requise. Reportez-vous aux informations ou documents joints afin de vous protéger contre les blessures ou les dommages à l'instrument.

Entretien et nettoyage

Entretien: ne pas exposer ce produit à la lumière directe du soleil pendant de longues périodes lorsqu'il est stocké ou placé.

Nettoyage: nettoyez uniquement l'extérieur de l'instrument à l'aide d'un chiffon doux et humide. N'utilisez pas de produits chimiques ou d'éléments abrasifs. Ne laissez en aucun cas l'humidité pénétrer dans l'instrument. Pour éviter les chocs électriques, débranchez le cordon d'alimentation de la prise secteur avant de le nettoyer.



ATTENTION:

Pour éviter d'endommager le produit, n'utilisez pas de réactifs corrosifs ou de nettoyage et ne les mettez pas dans des vapeurs, des liquides ou des solvants. S'il vous plaît confirmer que le produit est sec avant de le remettre sous tension pour l'utilisation et éviter les courts - circuits électriques ou même des blessures corporelles dues à l'humidité.

2 Product Introduction

SNA-TB01 is a RF demonstration board that includes several commonly used RF modules:

- 50 Ω short through line
- Mixer
- Amplifier
- Coupler
- Balun (RF transformer)
- Low-pass filter
- Band-pass filter
- 50 Ω long through line
- Impedance transformation line
- 100 Ω Differential line
- Differential impedance transformation line

SNA-TB01 is used for testing common RF circuit modules and to verify the relevant RF performance and indicators. This product is suitable for functional demonstrations in conjunction with vector network analyzers, and is also suitable as an introductory learning tool for RF engineers and instrument beginners.

2.1 Dimension

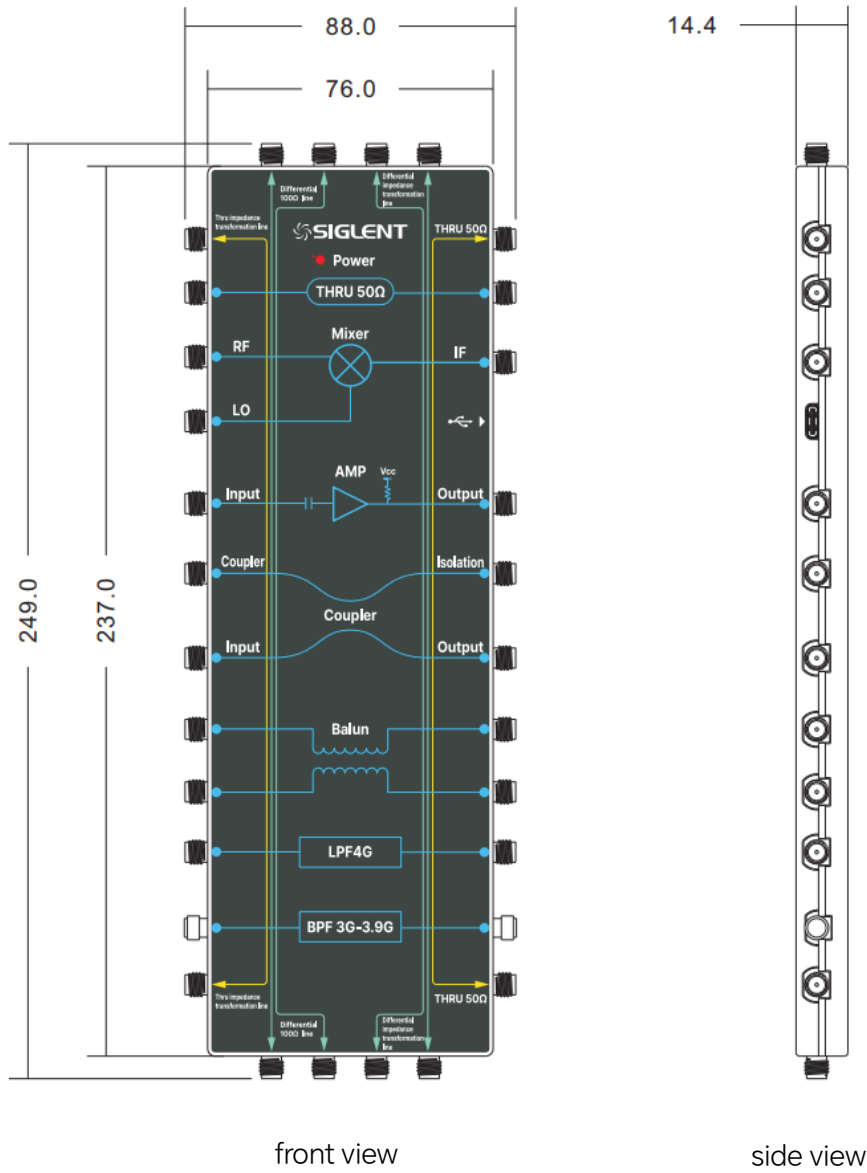

2.2 Front panel

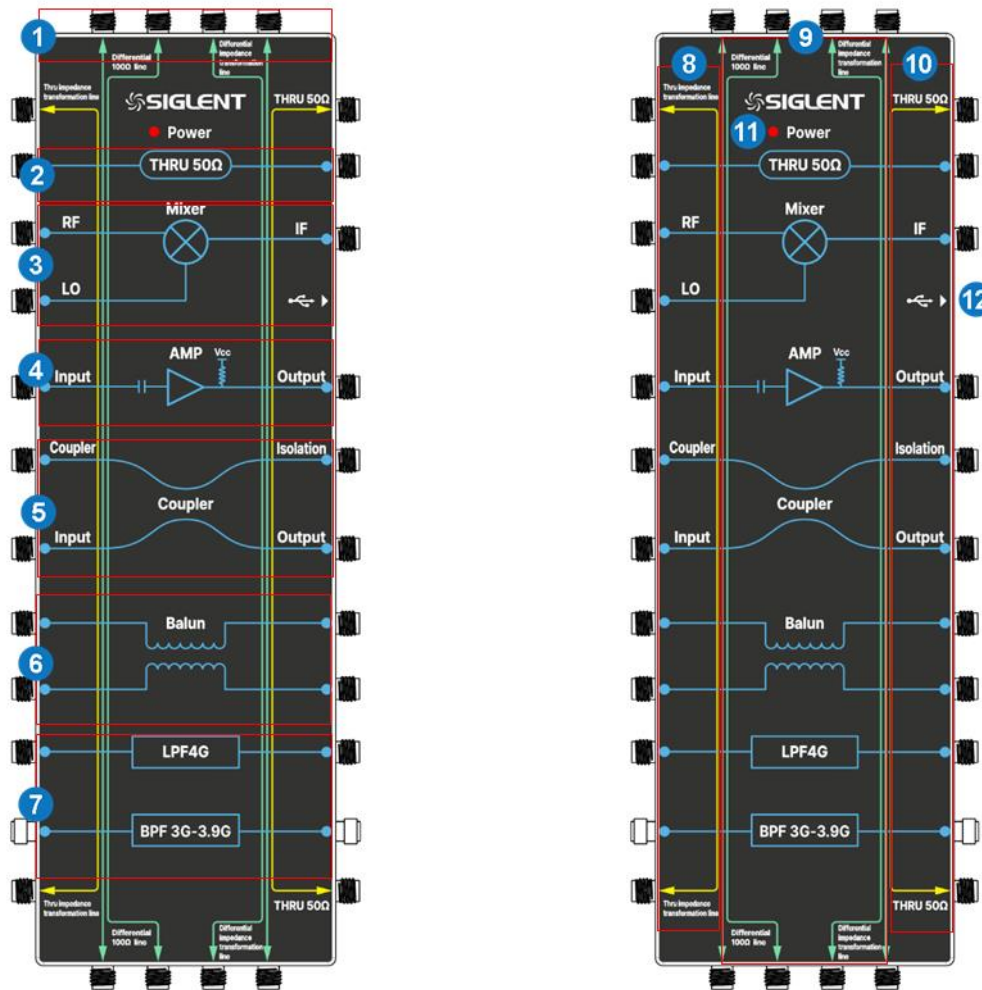

1. SMA female
2. 50 Ω short through line
3. Mixer
4. Amplifier
5. Coupler
6. Balun
7. Low-pass filter and band-pass filter
8. Impedance transformation line
9. 100 Ω differential line and differential impedance transformation line
10. 50 Ω long through line
11. Power supply indicator
12. USB-C power supply port

2.3 Rear panel

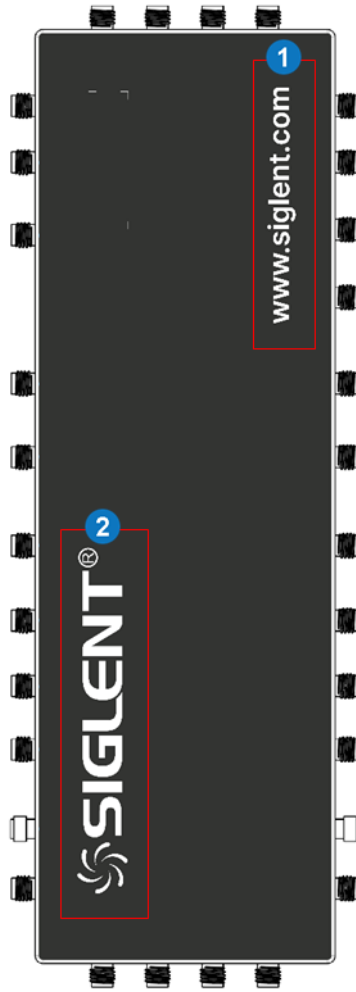

1. Official website address
2. The registered trademark of SIGLENT TECHNOLOGIES CO., LTD.

3 Module Introduction and Testing Indicators

3.1 50 Ω Short Through Line

SNA-TB01 has a through line, which is essentially a microstrip line with a characteristic impedance of 50 Ω, as shown in the following figure.



Figure 3-1 Schematic diagram of 50 Ω short through line

Through line is the most fundamental RF test module and the basic testing indicators are shown in the table below.

Test Indicators	Description
Transmission Loss	Indicates the loss generated by a signal passing a through line. S21 represents the forward transmission loss, and S12 represents the reverse transmission loss.
Return Loss	Indicates the reflection loss caused by impedance mismatch of the signal at the port, S11 represents input return loss, S22 represents output return loss.
SWR	Usually referred to as Voltage Standing Wave Ratio (VSWR), which is defined as the ratio of the wave belly voltage to the nodal voltage. VSWR and return loss can be converted to each other. The closer the value is to 1, the smaller the reflection on the through line.

3.2 Mixer

Mixer is a frequency conversion components that can mix the input frequency with the local oscillator signal to output a specific frequency. The output frequency is equal to the sum, difference, or other combination of the two input signal frequencies. Throughout the process, the input and output carrier waveforms maintain their modulation pattern unchanged, only moving from one frequency in the spectrum to another.

The mixer of SNA-TB01 is a three-port RF module, as shown in the following figure.

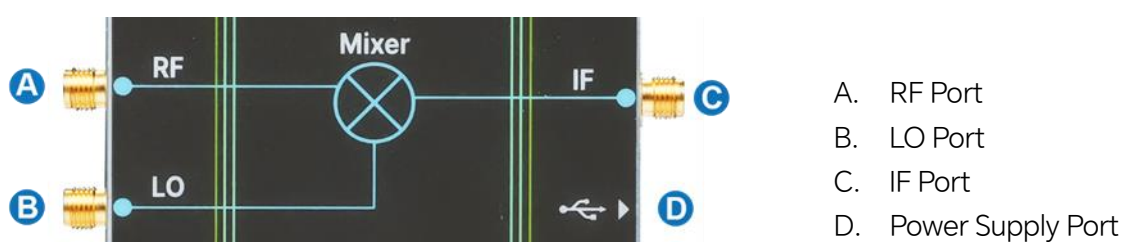

Figure 3-2 Schematic diagram of mixer module

The following is the schematic diagram of SNA-TB01 mixer module, which is composed of LTC5562 wideband active mixer.

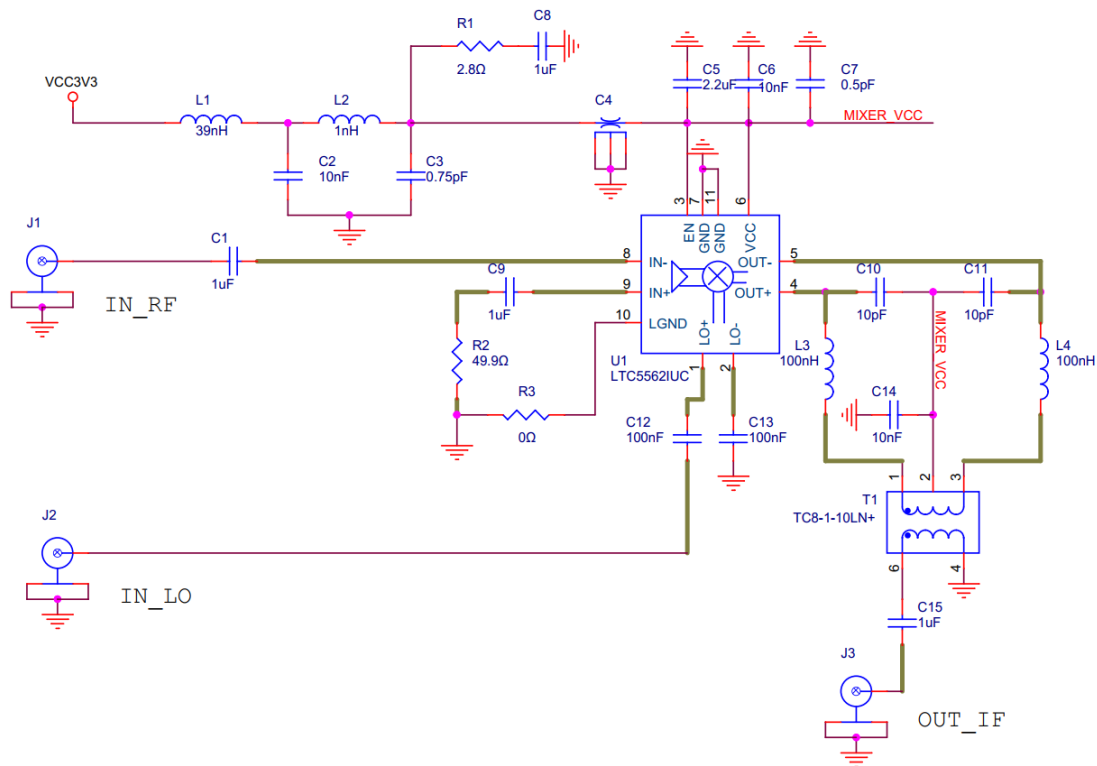

Figure 3-3 Mixer module schematic diagram

This mixer supports up-conversion and down-conversion. The frequency range of RF port is 30MHz to 7GHz, with a recommended RF power of -12dBm . The frequency range of IF port is 2MHz to 500MHz. The recommended power of the LO port is -1dBm . The mixer is an active device that requires $+3.3\text{V}$ DC power supply during testing. SNA-TB01 is equipped with the voltage regulator from 5V to 3.3V, so the power supply can be completed by connecting the USB-C cord to the USB interface on the front panel of the vector network analyzer. For more specifications on the mixer, please refer to the technical manual of LTC5562.

Due to the frequency conversion involved, it is recommended to use the SMM function of the vector network analyzer to test the mixer. The LO of the mixer can be provided by an external source or by the vector network analyzer itself. The following table shows the basic testing indicators of the mixer.

Test Indicators	Description
Conversion Loss (Gain)	The ratio of output power to input power, which indicates the loss of signal caused by the nonlinear characteristics of circuit components during the operation of the mixer, which can be represented by S21.
Input Match Output Match	Indicates the reflection loss caused by impedance mismatch at the port, where S11 represents input match and S22 represents output match.
Isolation	Indicates the power leaking from one port to another. The isolation degree from IF port to RF port can be represented by S12.

3.3 Amplifier

Amplifier can amplify transmitted signals and received signals in RF systems. Common types include low noise amplifier (LNA), variable gain amplifier (VGA), power amplifier (PA), etc.

The amplifier of SNA-TB01 belongs to low noise amplifier, which is a two-port module, as shown in the following figure. Low noise amplifiers are widely used in RF receivers to amplify the received signals while minimizing the impact of noise.

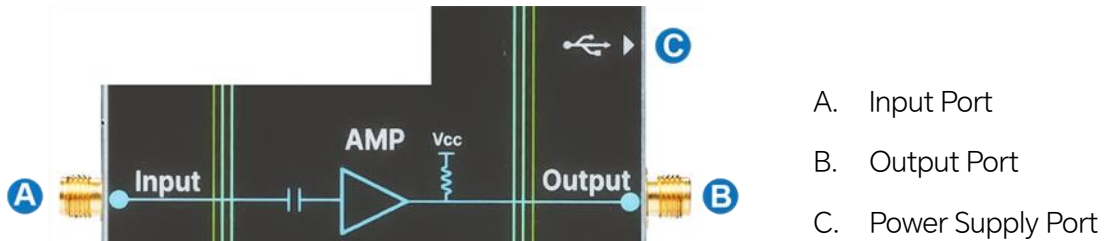

Figure 3-4 Schematic diagram of amplifier module

The following diagram is the schematic diagram of SNA-TB01 amplifier module, which uses the MAAM-011206 darlington broadband amplifier. The operating frequency of the amplifier is DC to 15GHz, with a gain of 13.5dB @ 6GHz (typical) and OP1dB of 18dBm @ 6GHz (typical). The amplifier is an active device that requires +5V DC power supply during testing, which can be completed by connecting the USB-C cord to the USB interface on the front panel of the vector network analyzer. Besides, external DC bias of +5V/0.1A can be applied at the output port of the amplifier. For more specifications on this amplifier, please refer to the technical manual of MAAM-011206.

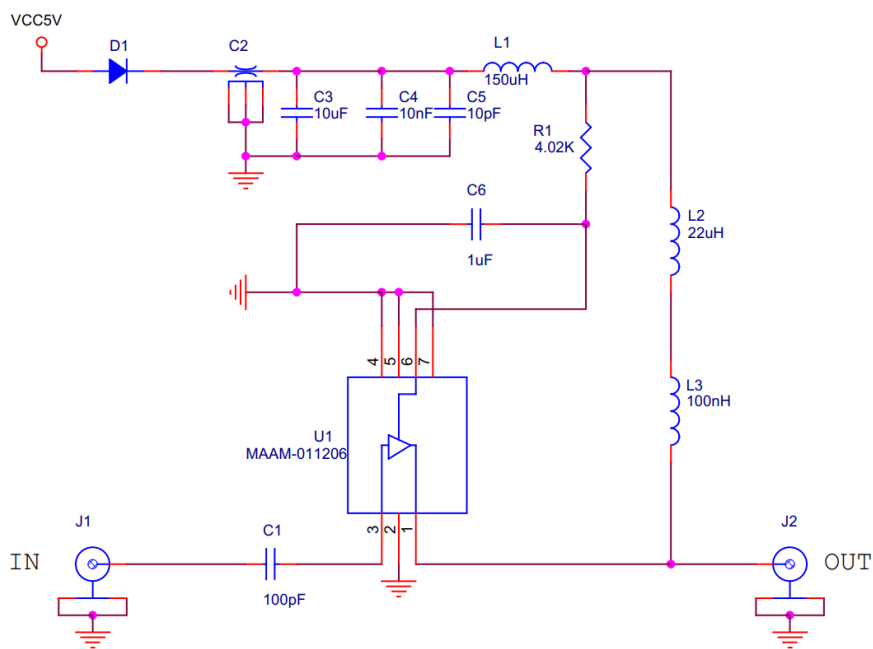

Figure 3-5 Schematic diagram of amplifier module

**CAUTION:**

To demonstrate the DC bias function of VNA, there is no DC isolation capacitor at the output port of the amplifier. Please be aware that any instruments and devices connected to the amplifier output port may suffer DC damage.

**NOTICE:**

When USB is used for power supply, the loss produced by the components of the bias circuit (such as inductance and diode) will make the amplifier working voltage lower than +5V, which means the gain and 1dB compression point may be less than the specification threshold. To achieve ideal performance similar to the specifications, please use the DC bias function to provide +5V external power supply.

The ideal amplifier has the ability of linear amplification, but the actual amplifier has nonlinear distortion effect. Therefore, in addition to linear parameters, compression parameters should also be included in the testing items. The basic testing indicators are shown in the table below.

Test Indicators	Description
Gain	The ratio of output power to input power, which indicates the ability of the input signal passing through and amplifying, represented by S21.
Return Loss	Indicates the reflection loss caused by impedance mismatch of the signal at the port. S11 represents input return loss, S22 represents output return loss.
Isolation	Indicates the power of the signal leakage from the output port to the input port, which is represented by S12.
Kfac	An important condition to measure the absolute stability of the amplifier. The greater the Kfac, the better the stability of the amplifier, the stronger the resistance to self-oscillation.
1dB Compression Point	An index to measure the linearity of the amplifier. When the input power of the amplifier increases to a certain value, the amplifier will enter the nonlinear region and the gain will decrease accordingly. When the gain of the amplifier drops to 1dB lower than the linear gain, the corresponding power is the 1dB compression point.
IP1dB	Input power at 1dB compression point.
OP1dB	Output power at 1dB compression point, which is equal to the sum of IP1dB and the gain at this point.
Harmonic Distortion	Indicates the multiple high-order harmonic components that generated in the output spectrum when the amplifier enters the nonlinear region.

3.4 Coupler

Coupler is a widely used RF device that can be used for signal isolation, separation, and mixing. In RF systems, it is often necessary to divide RF power of one channel into several channels, and the coupler can achieve the power-distribution function.

The coupler of SNA-TB01 is a directional coupler that can couple signals to a specified direction, with the operating frequency of 3GHz to 5GHz. The coupler has four ports, including input port, output port, coupling port, and isolation port, as shown in the following figure.

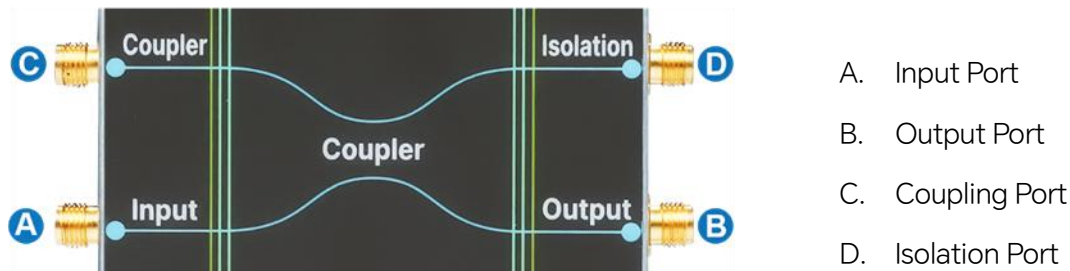

Figure 3-6 Schematic diagram of coupler

When testing the coupler, special attention should be paid to the distribution of power. The basic testing indicators are shown in the table below.

Test Indicators	Description
Input Return Loss	The reflection loss caused by impedance mismatch at the input port of the signal, which is represented by S11.
Insertion Loss	The ratio of output power to input power, which represents the transmission loss generated by the signal from the input port to the output port, represented by S21.
Coupling	The ratio of coupling power to input power, which represents the ability of a signal to couple from the input port to the coupling port, represented by S31.
Isolation	The ratio of isolated power to input power, which is represented by S41. In the ideal directional coupler, there is no power output at the isolation port. However, some power may leak out from this port actually.
Directivity	Directivity = Isolation / (Coupling × Insertion loss). Good directivity means the coupler can effectively couple the input signal to the output port, while restraining coupling to the isolation port.

3.5 Balun

Balun is based on the application of RF transformer, whose main function is to complete the transformation between single-ended transmission and differential transmission, also known as the transformation between imbalance and balance. Differential signals are less affected by noise and crosstalk than single-ended signals. In an ideal balun, the common mode signal will completely reflect while the differential mode signal will pass through completely, which means that the common mode rejection ratio (CMRR) is an important characteristic. In addition, balun has others functions such as impedance matching, DC-blocking, AC-pass, step-up, step-down, etc.

The Balun of SNA-TB01 is a four-port module, as shown in the following figure. This Balun is based on TC1-1-13MG2+ RF transformer, operating in the frequency band of 4.5 MHz to 3 GHz.

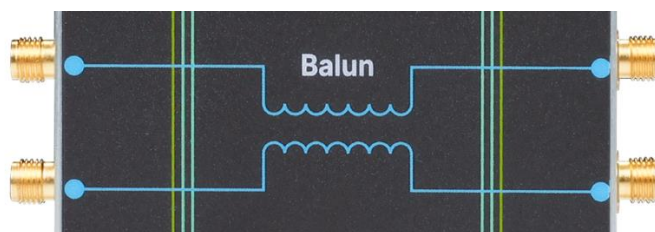

Figure 3-7 Schematic diagram of balun

When measuring the balun, due to the fact that the actual differential signal is always composed of differential and common mode signals, the single-ended S-parameter cannot provide insightful information about differential and common mode matching and transmission. Therefore, mixed S-parameters have become an important tool for evaluating differential transmission systems. The representation of the mixed S parameter is Sabxy, where “a” represents the output mode, “b” represents the input mode, “x” and “y” correspond to the logical port numbers of the input and output. “a” and “b” choose one of the following: “s” represents single-ended, “d” represents differential mode, and “c” represents common mode. Therefore, Sdd represents the differential mode S-parameter, Scc represents the common mode S-parameter, Sdc represents the conversion from differential mode to common mode, and Scd represents the conversion from common mode to differential mode.

The following table gives the basic differential testing indicators of Balun.

Test Indicators	Description
Differential Insertion Loss	Insertion loss of differential signals, which is represented by Sdd12. The lower the differential insertion loss, the greater the signal power passing through Balun, the wider the dynamic range, and the smaller the signal distortion.
Differential Return Loss	Return loss of differential signals, which is represented by Sdd11.
Common Mode Rejection Ratio (CMRR)	One of the main indicators of Balun. If two identical signals with the same phase (common mode signals) are injected into Balun's balanced port, they will be reflected or absorbed. The attenuation of the signal from the balanced port to the unbalanced port is CMRR. CMRR is defined as the ratio of differential insertion loss to common mode insertion loss of a balanced port, i.e. Sdd21/Scc21. The higher the CMRR, the better the common mode rejection.

3.6 Filter

Filter is a two-port module, which can filter out specific frequency components in the signal. An ideal filter has no attenuation in the passband, but has infinite attenuation in the stopband, so it is an indispensable component of RF system.

SNA-TB01 has two types of filter, one is a low-pass filter, the other is a band-pass filter, as shown in the following figure.



Figure 3-8 Schematic diagram of low-pass filter and band-pass filter

The cut-off frequency of the low-pass filter is 4GHz, and the passband range of the band-pass filter is 3GHz-3.9GHz. The following table gives the basic testing indicators of the filter.

Test Indicators	Description
Cut-off Frequency	It refers to the frequency at which the output signal attenuates by -3dB when the input signal is constant. Band-pass filter has cut-off frequencies at both low band and high band, while low-pass filter only has a cut-off frequency at high band.
Quality Factor (Q)	The ratio of center frequency to bandwidth, which characterizes the frequency selectivity of the filter. The higher the Q, the stronger the frequency selectivity of the filter.
Insertion Loss	The ratio of output power to input power, which characterizes the ability of useful signals to pass through the filter, represented by S21.
Ripple Within the Passband	The fluctuation of the signal within the passband, which is usually represented by the peak to peak value of the S21 curve.
Return Loss	Indicates the reflection loss caused by impedance mismatch at the port, where S11 represents input return loss and S22 represents output return loss.
Delay	The time taken for the signal to be transmitted from the input port to the output port within the passband.
Delay Ripple	Indicates the fluctuation degree of delay within the passband, which characterizes the dispersion characteristics. The smaller the fluctuation, the better.
Out-band Suppression	The attenuation of the filter outside the passband, which characterizes the ability to suppress unwanted frequency signals.

3.7 Long Through Line and Impedance Transformation Line

SNA-TB01 has a 50 Ω long microstrip through line and a microstrip impedance transformation line, as shown in the following figure.

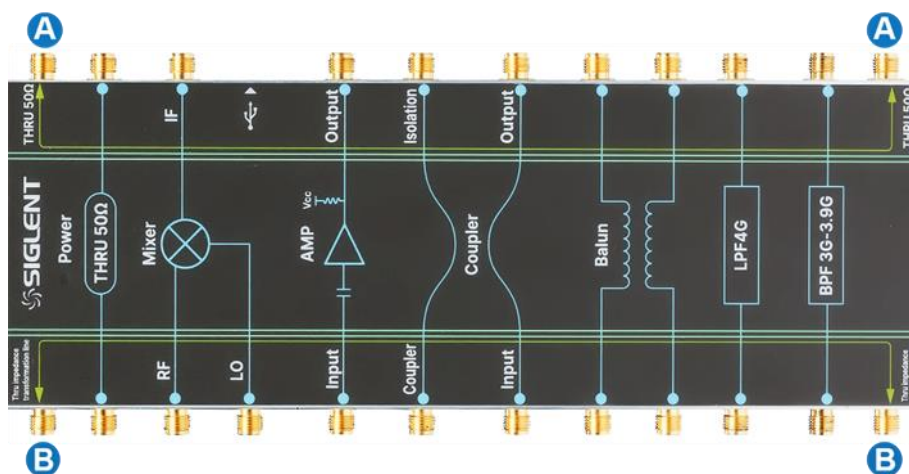

Figure 3-9 Schematic diagram of long through line and impedance transformation line

- A. Ports of Long Through Line
- B. Ports of Impedance Transformation Line

The characteristic impedance of the long through line is 50 Ω, and the variation of the characteristic impedance of the impedance transformation line with length is: 50Ω ~ 75Ω ~ 25Ω ~ 50Ω. The dielectric constants of both are 3.48.

Due to the long length of the line (about 21cm), in addition to the conventional S-parameter, the impedance variation with distance is also worthy of attention. Therefore, it is recommended to use the time-domain reflectometer (TDR) function of vector network analyzer to measure and analyze the impedance at different positions on the transformation line. The following table gives the basic testing indicators of the long through line and the impedance transformation line.

Test Indicators	Description
Transmission Loss	Indicates the loss generated by a signal passing the through line. S21 represents the forward transmission loss, and S12 represents the reverse transmission loss.
Return Loss	Indicates the reflection loss caused by impedance mismatch of the signal at the port. S11 represents the input return loss, and S22 represents the output return loss.
Impedance	The inherent characteristics of a transmission line, which are defined as the ratio of the incident wave voltage to the incident wave current on the transmission line. The TDR function of the vector network analyzer can be used to analyze the impedance variation with distance.

3.8 Differential Line and Differential Impedance Transformation Line

Differential line transmits the same signal with a phase difference of 180 degrees, which consists of two parallel, coupled, equal-length lines. One line transmits a positive signal and the other transmits a negative signal. Differential line has good anti-interference ability and is commonly used for high-speed signal transmission.

SNA-TB01 has a 100 Ω differential line and a differential impedance transformation line, as shown in the following figure.

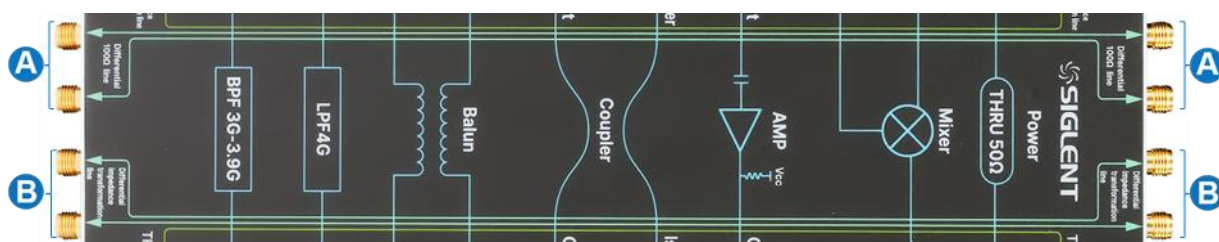

Figure 3-10 Schematic diagram of differential line and differential impedance transformation line

- A. Ports of Differential Line
- B. Ports of Differential Impedance Transformation Line

The differential impedance of the differential line is 100 Ω, and the variation of the differential impedance of the differential impedance transformation line with length is: 100Ω ~ 120Ω ~ 75Ω ~ 100Ω. The dielectric constants of both are 3.48.

Due to the long length of the line (about 21cm), in addition to the conventional mixed S-parameters, the differential impedance variation with distance is also worthy of attention. Therefore, Therefore, it is recommended to use the time-domain reflectometer (TDR) function of vector network analyzer to measure and analyze the differential impedance at different positions on the transformation line. The following table gives the basic testing indicators for the differential line and the differential impedance transformation line.

Test indicators	Description
Differential Insertion Loss	Insertion loss of differential signals, which represented by Sdd21. The lower the differential insertion loss, the less loss through the differential line.
Differential Return Loss	The return loss of differential signals. Sdd11 represents the input differential return loss, and Sdd22 represents the output differential return loss.
Differential Impedance	The ratio of differential signal voltage to current, which can be regarded as the equivalent series impedance of two single-ended lines (coupling not considered). The TDR function of the vector network analyzer can be used to analyze the variation of differential impedance with distance.

4 Test Guide

4.1 Document Conventions

This chapter takes Siglent Technologies's SNA series vector network analyzer as an example to guide the testing process of the SNA-TB01 RF demonstration board.

For convenience, text surrounded by a box border is used to represent the button of the front panel. For example, Meas represents the "Meas" button on the front panel. Italicized text with shading is used to represent the touchable or clickable menu/option/virtual button on the touch screen. For example, S11 represents the "S11" option on the screen.

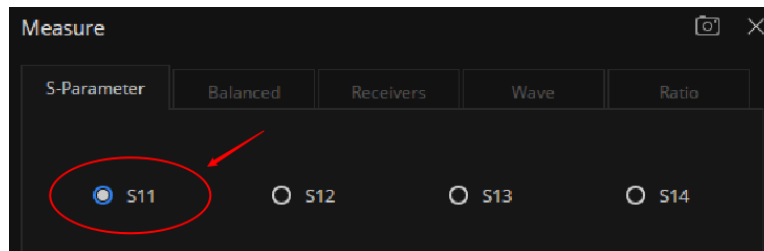

For the operations that contain multiple steps, the description is in the form of "Step 1 > Step 2 >...". As an example, change sweep type:

Sweep > Sweep Type > Power Sweep

Press the Sweep button on the front panel as step 1, click the Sweep Type option on the screen as step 2, and click the Power Sweep option on the screen as step 3 to switch the sweep type to power sweep.

4.2 Prepare before Testing

4.2.1 Testing Instrument and Tool

Before testing, relevant testing instruments and tools need to be prepared, as shown in the table below.

Test Module	Test Instrument and Tool
50Ω Short Through Line	Vector network analyzer, Cables
Mixer	Internal source for LO: Vector network analyzer (4-port, equipped with SMM option), USB-C cord, Cables External source for LO: Vector network analyzer (equipped with SMM option), RF signal generators, USB-C cord, Cables
Amplifier	Vector network analyzer, USB-C cord, Cables
Coupler	Vector network analyzer ^[1] , Cables
Balun	Vector network analyzer ^[1] , Cables

Filter	Vector network analyzer, Cables
Long Through Line and Impedance Transformation Line	Vector network analyzer (equipped with TDR option) , Cables
Differential Line and Differential Impedance Transformation Line	Vector network analyzer (equipped with TDR option) ^[1] , Cables
[1] It is recommended to use a 4-port vector network analyzer for testing. If using a 2-port vector network analyzer, 50 Ω loads need to be prepared.	

4.2.2 Instrument Setup and Calibration

Preheating: After the vector network analyzer is turned on, it should be preheated for more than half an hour to ensure that all components of the instrument work stably. The test results of the instrument will be more accurate in this way.

Basic parameter settings: Before calibration, the basic parameters of the vector network analyzer should be set properly, such as frequency range, IFBW, number of points, sweep type, power level, etc. Please refer to the user manual of the vector network analyzer for details.

Basic Parameters	Meaning and Settings
Frequency Range	Determined by the operating frequency of the tested module.
IFBW	Setting a narrower IFBW can improve the noise base, dynamic range and trace noise, but the sweep speed will be slower. The setting principle is to use a wider IFBW as much as possible while ensuring the required dynamic range and trace noise. IFBW is usually set to 10kHz or 1kHz.
Number of Points	To obtain a high resolution of trace, more points should be set. To achieve a faster sweep speed, fewer points should be set. Number of Points is usually set to 201/401/801/1601, etc.
Sweep Type	Includes linear frequency, log frequency, power sweep, CW time, and segmented sweep. Linear frequency is chosen for testing generally, but other sweep types can also be selected depending on the characteristics of DUT. For example, power sweep can be selected for measuring the compression characteristics of the amplifier, segmented sweep can be selected for measuring the filter, and CW time can be selected for measuring a certain frequency.
Power Level	The output power at the port of the vector network analyzer, which is generally set to 0dBm or -10dBm.

Calibration: The instrument is imperfect and has systematic errors, the testing cables and adapters will also introduce extra errors. Therefore, the vector network analyzer needs to be calibrated before testing. Mechanical or electronic calibration can be used for calibration, and different calibration methods will directly affect the accuracy of test results. Please refer to the user manual of the vector network analyzer for details. When any of the basic parameters (frequency range, IFBW, etc.), cable status or temperature change, it is recommended to recalibrate.

4.3 Test Step

4.3.1 50 Ω Short Through Line

1. Preheat the VNA, set basic parameters such as frequency range and number of points, and then perform full two port calibration.
2. Connect the 50 Ω short through line to the VNA by cables.
3. Click  at the top of the screen to add four measurement traces.
4. Click **Meas** > *S-params* and set the four traces as S11, S21, S12, and S22. Among them, S11 is the input return loss, S21 is the forward transmission loss, S12 is the reverse transmission loss, and S22 is the output return loss. If you want to check input or output SWR, select the S11 or S22 trace and then click **Format** > *SWR* .

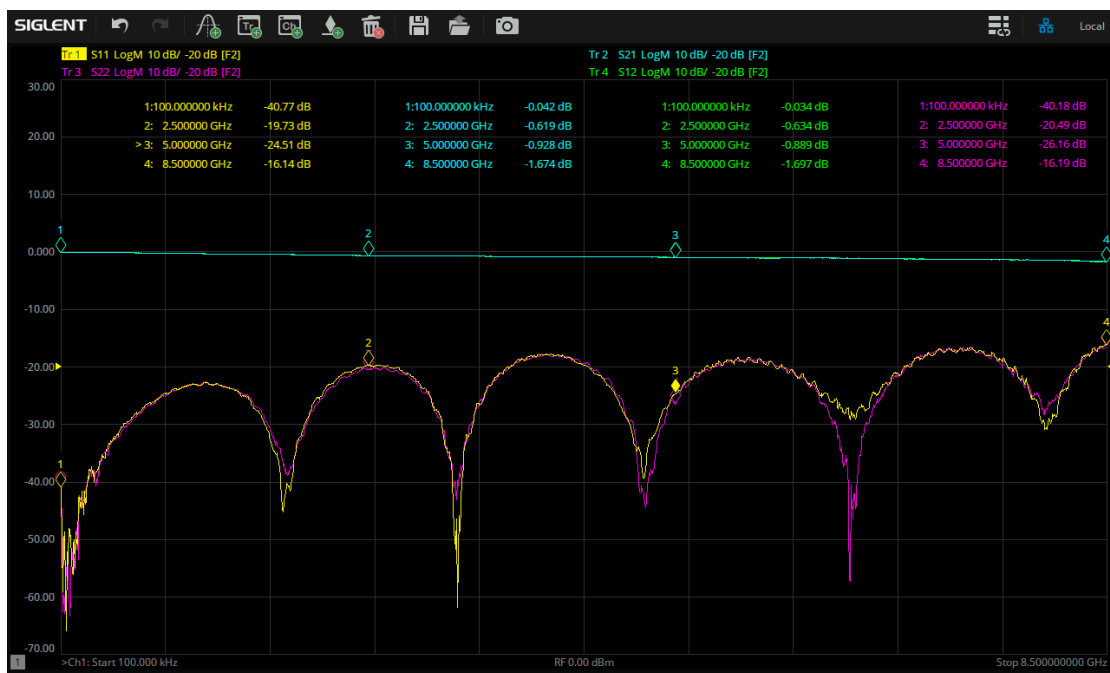



Figure 4-1 Test result of 50 Ω short through line

4.3.2 Mixer

1. Preheat the VNA.
2. Connect the mixer to the VNA by cables. The local oscillator of the mixer can be provided by VNA internal source or the external source.
 - If using VNA internal source as the local oscillator, connect RF port of the mixer to VNA port 1, IF port to VNA port 2, and LO port to VNA port 3.
 - If using external source as the local oscillator, connect RF port of the mixer to VNA port 1, IF port to VNA port 2, and LO port to the output port of the external source. Then, connect the external source to USB interface of VNA.

3. Click **Meas** > **Mode...** > **SMM** to enter scalar mixer measurement mode.
4. After entering SMM mode, the system will automatically pop up the Mixer Measure Steup. Users can also click **Sweep** > **Mixer Measure...** to enter.
 - In the Sweep tab, set the Sweep Type to Linear Frequency.
 - In the Power tab, select the DUT Input Port as Port1 and set Power Level to -12dBm.
 - In the Mixer Frequency tab, select Input as Start/Top and set the frequency range from 5.6GHz to 6GHz. Select Local as Fixed and set the frequency to 5.5GHz. Select Output as Start/Stop, with down conversion (-) and set the frequency range from 100MHz to 500MHz.
 - In the Mixer Setup tab, if VNA internal source is used as LO, set Local to Port3. If external source is used as LO, set Local to the corresponding external source. Set Local Power Level to -1dBm.
5. Click **Cal** > **Mixer Cal...** to perform full two port calibration, then connect a USB power meter for power calibration.
6. Use a USB-C cord to connect the mixer power supply port with the VNA USB hub, and the power indicator of SNA-TB01 will light up.
7. Click  at the top of the screen to add four measurement traces.
8. Click **Meas** > **S-params** and set the four traces as S11, S21, S12, and S22. Among them, S11 is input matching, S21 is conversion loss, S12 is isolation, and S22 is output matching.
9. Click  at the top of the screen to add markers.

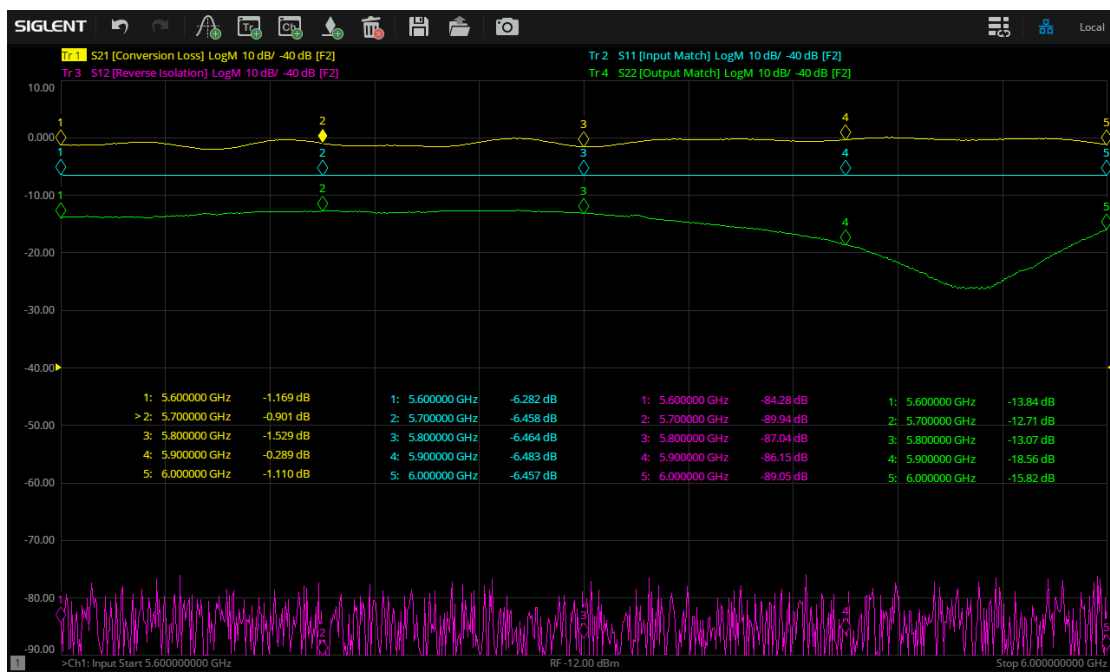



Figure 4-2 Test result of mixer

4.3.3 Amplifier

1. Preheat the VNA, set basic parameters such as sweep type (linear frequency), frequency range, and number of points, and then perform full two port calibration.
2. Connect the amplifier to the VNA by cables, with VNA port 1 connected to the amplifier input and VNA port 2 connected to the amplifier output.
3. Use a USB-C cord to connect the amplifier power supply port with the VNA USB hub, and the power indicator of SNA-TB01 will light up.
4. Click  at the top of the screen to add five measurement traces.
5. Click **Meas** > *S-params* and set the four traces as S11, S21, S12, and S22. Among them, S11 is input return loss, S21 is gain, S12 is isolation, and S22 is output return loss.
6. Select the fifth trace (Tr5), click **Math** > *Analysis* > *Equation Editor...* > *Advanced*, set the formula to $kfac(S11, S21, S12, S22)$ and enable Equation. Then, click **Format** > *Lin Mag*.
7. Click  at the top of the screen to add markers, and the traces of the linear frequency sweep can be observed.

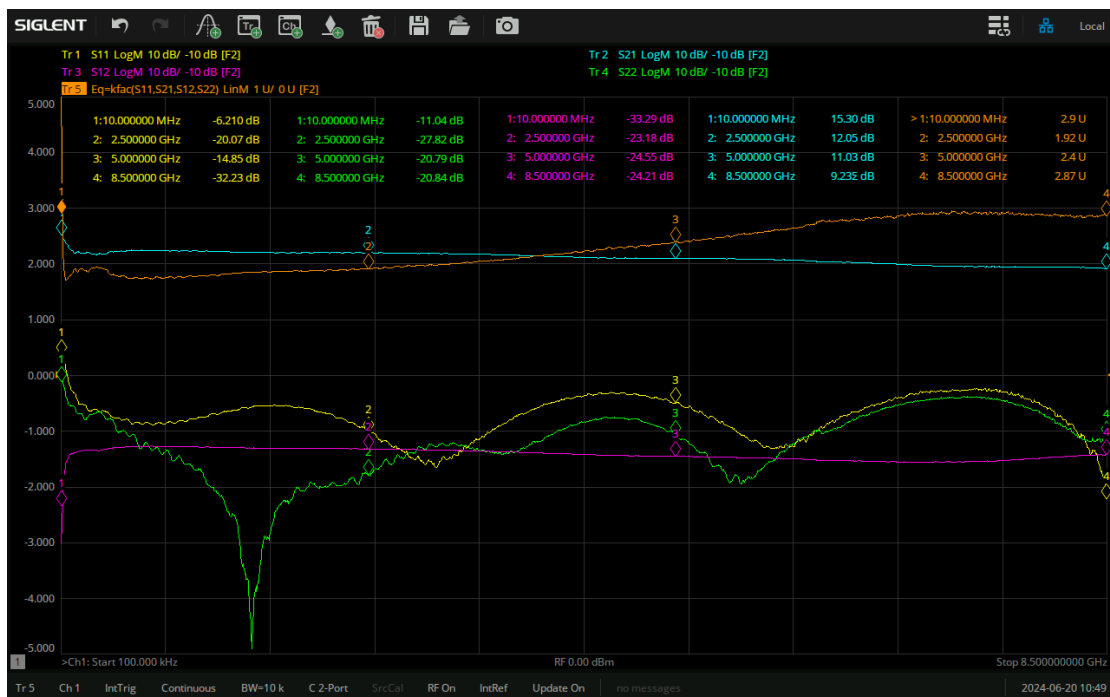

Figure 4-3 Test result of amplifier with linear frequency sweep

8. Click **Sweep** > *Sweep Type* and change the sweep type to Power Sweep.
9. Click **Power**, set Start Power to -15dBm, and set Stop Power to 10dBm.

**CAUTION:**

When measuring the amplifier, please pay attention to the gain of the amplifier and the maximum input power of the VNA. Set the power level of the VNA within a safe range to prevent damage to the instrument. The amplifier of this product has a gain of about 15dB, and the input damage level of the SNA series VNA is +27dBm. To ensure safety, the power level of VNA needs to be set to +10dBm or below. If necessary, external attenuators can be used.

10. It is significant to provide correct power level to the DUT when performing absolute power measurements. To improve the power measurement accuracy of the amplifier, it is recommended to use a power meter to calibrate the source power and receiver of the VNA.

Three measurement traces are retained in the screen, set them to S21, R1 Source Port1 and B Source Port1. R1 Source Port1 is the power trace of port 1 reference receiver, click **Meas** > **Receiver** > **R1 Source Port 1** to check. B Source Port1 is the power trace of port 1 measurement receiver, click **Meas** > **Receiver** > **B Source Port 1** to check.

11. Click **Scale** > **Auto Scale All**, adjust the display scale to make the traces more visible.
12. Retain two Markers. Marker1 moves to the flat area on the left side of the S21 trace, which is located in the linear area. Marker2 moves to the point that is 1dB lower than Marker1, which is the 1dB compression point of the amplifier. IP1dB is the horizontal axis corresponding to Marker2, and OP1dB is the sum of IP1dB and S21. To a certain extent, the traces of R1 Source Port1 and B Source Port1 can reflect the changes in input and output power of the amplifier. It can be observed that after the 1dB compression point, the output power of the amplifier tends to saturate and no longer increases linearly with the increase of input power.
13. In addition, this amplifier can also use VNA's DC bias function for power supply. Connect the external +5V/0.1A DC power supply to the DC bias port on the back of the VNA through a BNC cable, and the DC power will enter the test cable connected to the output port of the amplifier, thereby completing the power drive of the amplifier.

**Tip:**

The BNC cable should be connected to the DC bias port corresponding to the amplifier output port.

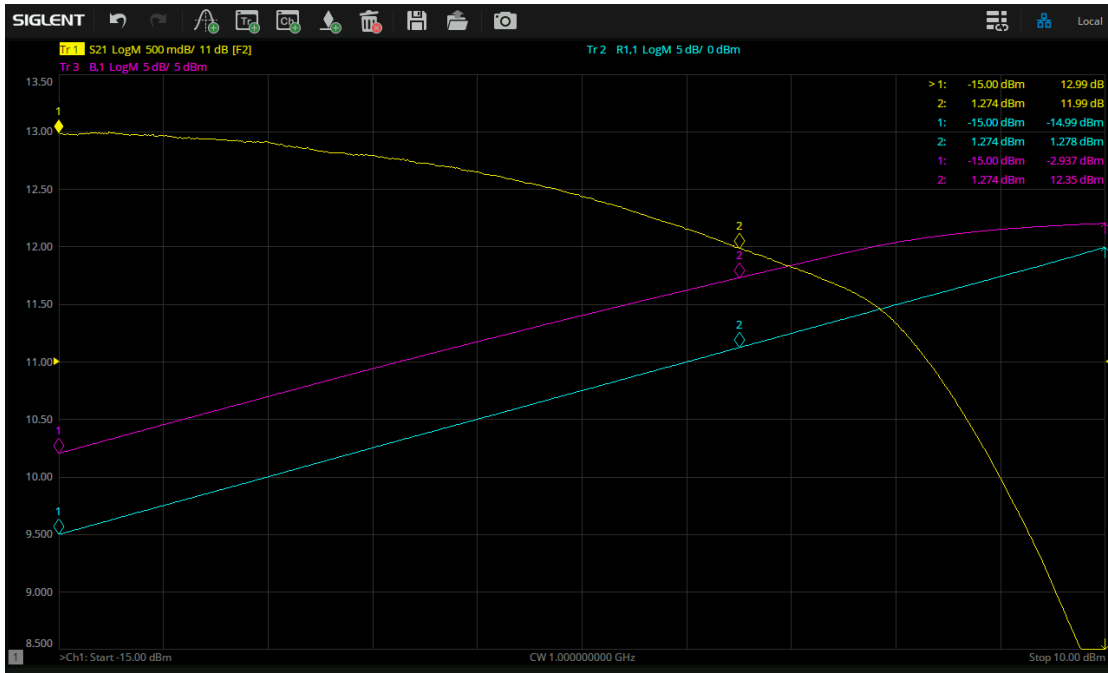

Figure 4-4 Test result of amplifier with power sweep

14. If the VNA is equipped with SA option, the output spectrum of the amplifier can be observed. Click **Meas** > **Mode...** > **SA** to enter spectrum analysis mode.
15. After entering SA mode, the system will automatically pop up SA Steup. Users can also click **Sweep** > **SA Setup...** to enter SA Steup.
 - In the SA tab, set basic settings such as frequency range and number of points, and set RF Input to B(Port 2), which is the output port of the amplifier.
 - In the Source tab, turn on the power of port 1, select CW for the sweep type, and set different power levels.

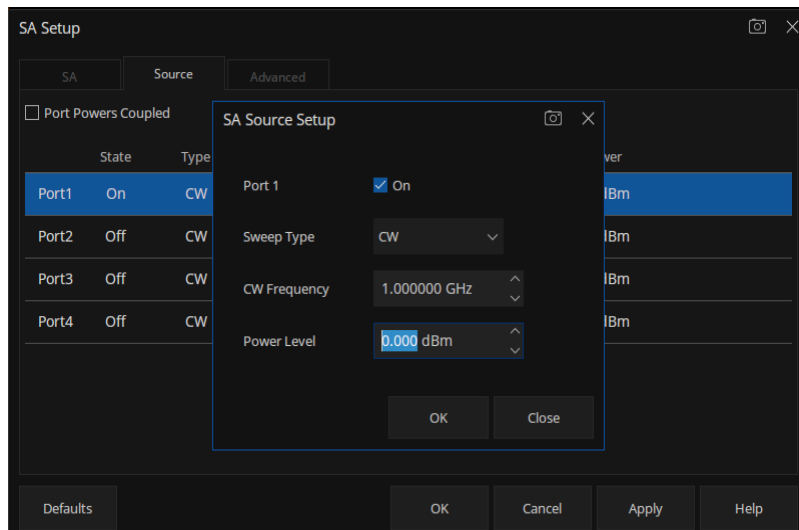

Figure 4-5 SA Source Setup interface for amplifier input port

16. Observe the impact of power level at the input port on the output spectrum. When the input power level is low, the amplifier is in the linear amplification region, and the power increases linearly with the increase of the input signal. When the input power level is greater than IP1dB, the amplifier produces harmonic distortion, multiple high-order harmonics are generated in the output signal. The amplifier enters a nonlinear saturation region, resulting in compressed output power.

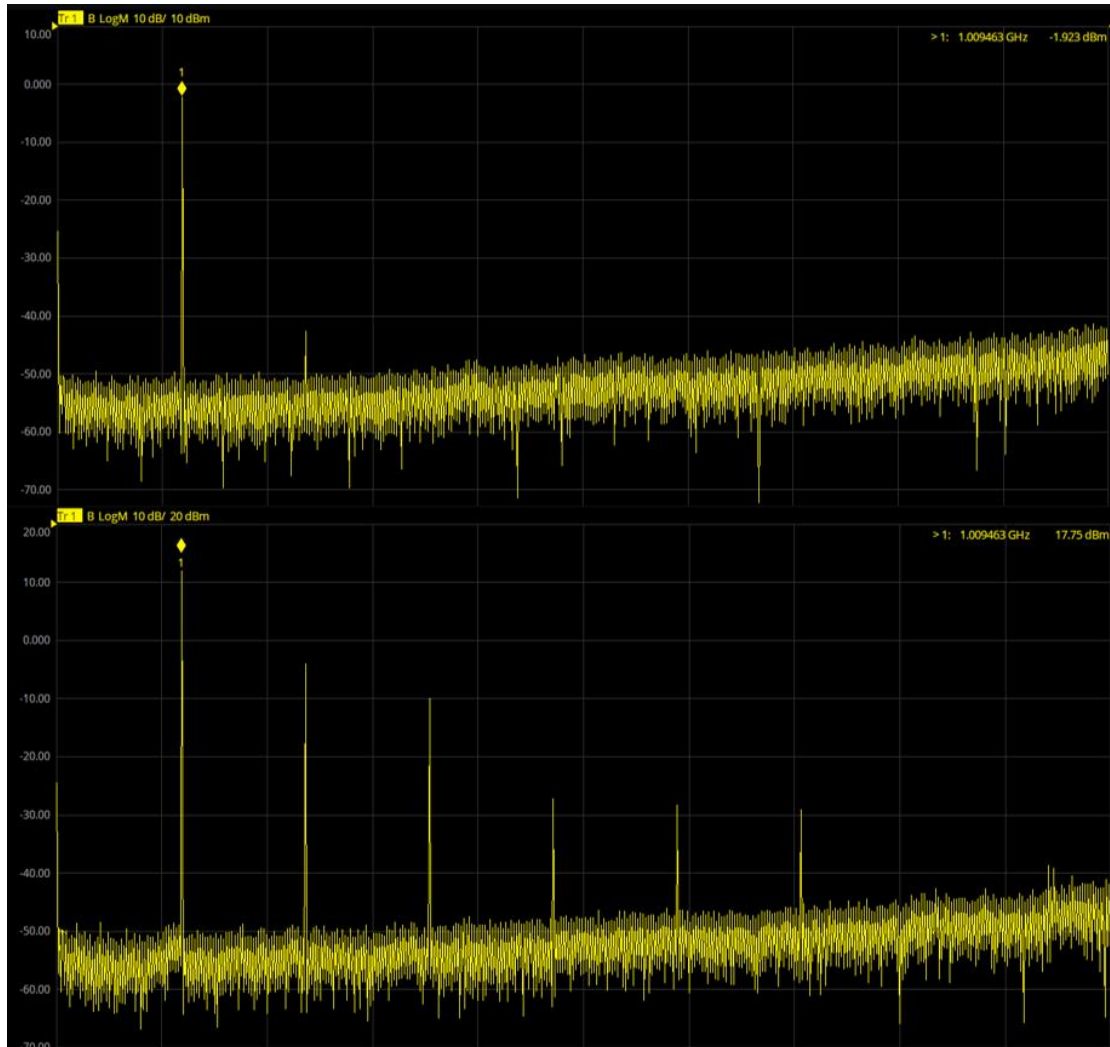

Figure 4-6 Spectrum test result of the linear (upper) and nonlinear (lower) regions of the amplifier

4.3.4 Coupler





1. Use a 4-port vector network analyzer, preheat the VNA, and set the basic parameters such as frequency range (3GHz to 5GHz) and number of points, then perform full four port calibration.
2. Connect the coupler to the VNA by cables. Connect the coupler input port to VNA port 1, the coupler output port to VNA port 2, the coupler coupling port to VNA port 3, the coupler isolation port to VNA port 4.
3. Click  at the top of the screen to add five measurement traces.
4. Click **Meas** > *S-params* and set the four traces as S11, S21, S31, and S41. Among them, S11 is input return loss, S21 is insertion loss, S31 is coupling, and S41 is isolation.
5. Select the fifth trace (Tr5), click **Math** > *Analysis* > *Equation Editor...*, set the directivity formula as $S_{41}/S_{31}/S_{21}$ and enable Equation.
6. Click  at the top of the screen to add markers.



Figure 4-7 Test result of coupler

7. If a 2-port vector network analyzer is used, connect VNA port 1 to the coupler input port, and VNA port 2 to the coupler output port, coupling port and isolation port respectively. Refer to the above steps to test S-Params for each connection situation. During the test, 50 Ω loads need to be connected to the unconnected ports of the coupler.

4.3.5 Balun

1. Use a 4-port vector network analyzer, preheat the VNA, set basic parameters such as frequency range (4.5MHz to 3GHz) and number of points, then perform full four port calibration.
2. Click **Meas** > **Balanced** > **Topology...**, select **BAL-BAL**, and set the appropriate connection topology. Port 1 and 2 correspond to the two ports on one side of Balun, a port 3 and 4 correspond to the two ports on the other side of Balun.
3. Connect Balun to the VNA and by cables according to the previous connection topology.
4. Click  at the top of the screen to add three measurement traces.
5. Click **Meas** > **Balanced** > **Other...** and set the three traces as Sdd11, Sdd21, and Sdd21/Scs21. Among them, Sdd11 is differential return loss, Sdd21 is differential insertion loss, and Sdd21/Scs21 is common mode rejection ratio.
6. Click  at the top of the screen to add markers.

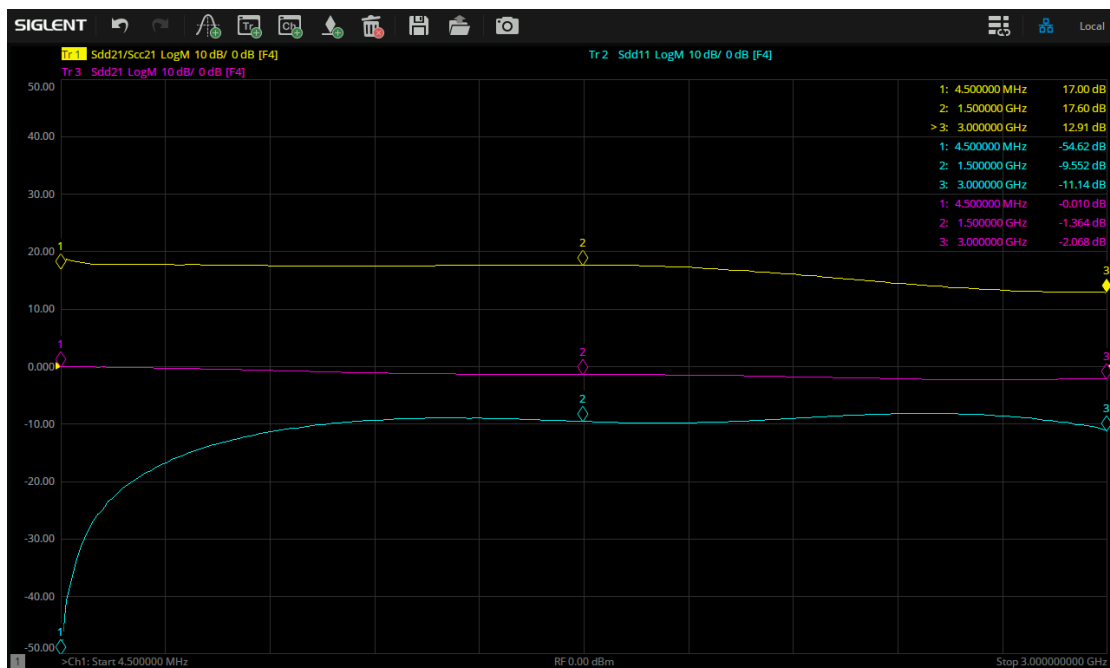



Figure 4-8 Test result of balun

7. If a 2-port vector network analyzer is used, only differential return loss can be tested. Connect port 1 and port 2 to the same side of Balun, follow the above steps, set port topology to BAL and check Sdd11. During the test, 50 Ω loads need to be connected to the unconnected ports of the balun.

4.3.6 Filter

1. Preheat the VNA, set basic parameters such as frequency range and number of points, and then perform full two port calibration.
2. Connect the filter to the VNA by cables.
3. Click  at the top of the screen and set four measurement traces as S11, S21, S21 Delay, and S22. Among them, S11 is input return loss, S22 is output return loss, S21 is insertion loss. Click **Format** > *Delay* to view S21 Dealy.
4. Click **Scale**, adjust the display scale appropriately so that all traces can be observed.
5. Click  at the top of the screen to add markers. Marker1 needs to be in the passband of the filter.
6. For the S21 trace, click **Search** > *Bandwidth Search* > **On**, and select the BW Ref To Marker. For the band-pass filter, BW, Center, High/Low, Q, and Loss can be displayed. For the low-pass filter, High can be displayed.
7. Select S21 and S21 Delay traces, click **Math** > *Analysis* > *Statistics* > **On**, then click *Statistics Range*, set the User Span range to the passband range of the filter, and use Peak to Peak to view the ripple of the selected trace within the passband range.

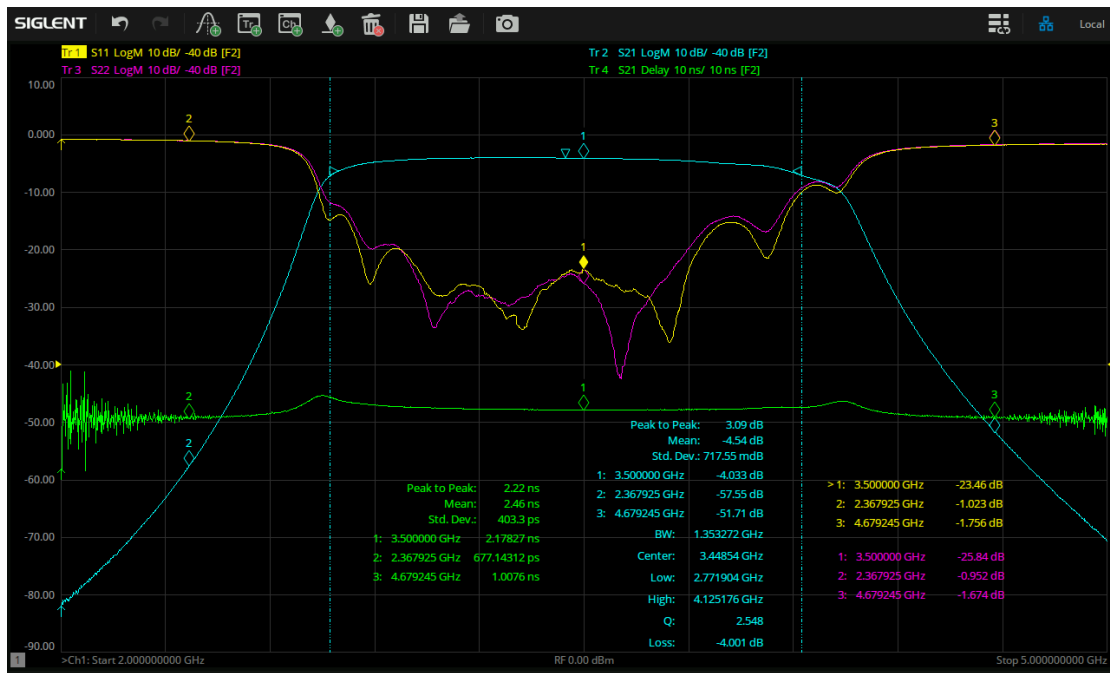

Figure 4-9 Test result of band-pass filter

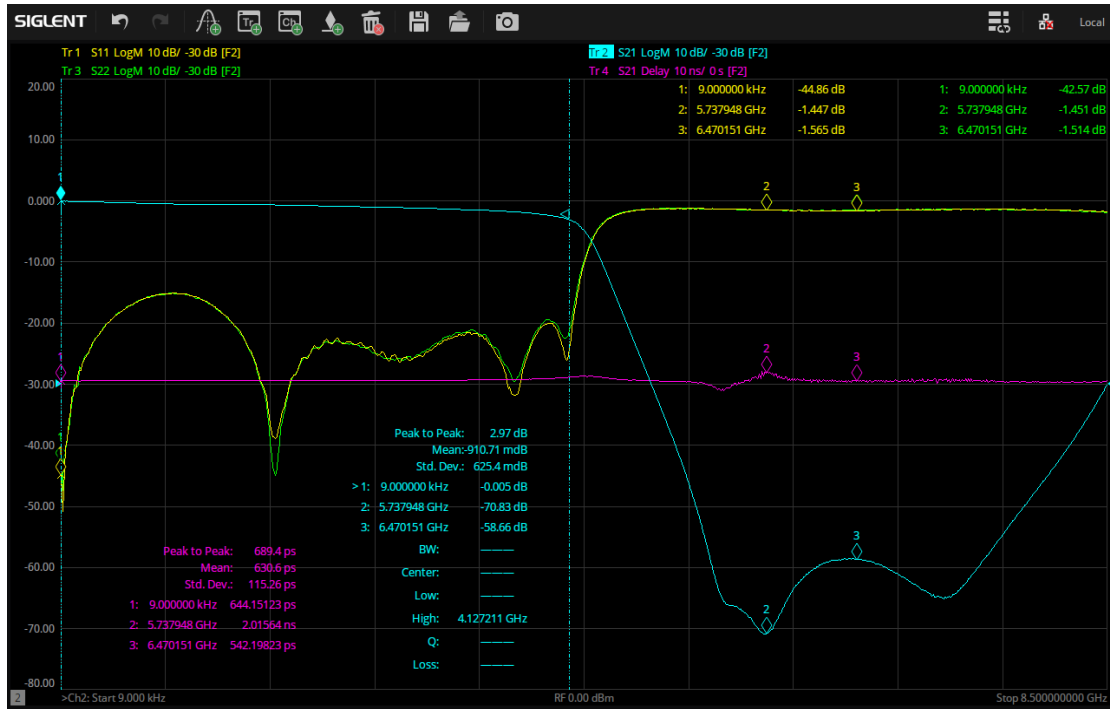

Figure 4-10 Test result of low-pass filter

8. In order to obtain more accurate results without reducing sweep speed, different basic parameter settings can be used for different bands of the filter. Click **Sweep** > **Sweep Type** > **Segment Sweep** to change the sweep type of VNA to segment sweep. Click **Sweep** > **Segment Table** to add segments. The passband can use a wider IFBW (such as 10kHz) and more points (such as 1001), while the stopband can use a narrower IFBW (such as 100Hz or 1kHz) and fewer points (such as 201).



+	State	Start	Stop	Points	IF Bandwidth
1	On	2.000000000 GHz	2.700000000 GHz	201	100 Hz
2	On	2.700000000 GHz	4.200000000 GHz	1001	10 kHz
> 3	On	4.200000000 GHz	5.000000000 GHz	201	100 Hz

+	State	Start	Stop	Points	IF Bandwidth
1	On	9.000 kHz	4.200000000 GHz	1001	10 kHz
> 2	On	4.200000000 GHz	8.500000000 GHz	201	100 Hz

Figure 4-11 Segment table for band-pass filter (upper) and low-pass filter (lower)

4.3.7 Long Through Line and Impedance Transformation Line

S-parameter Test :

1. Preheat the VNA, set basic parameters such as frequency range and number of points, and perform full two port calibration.
2. Connect the long through line or impedance transformation line to the VNA by cables.
3. Click  at the top of the screen to add four measurement traces.
4. Click **Meas** > *S-params* and set the four traces as S11, S21, S12, and S22. Among them, S11 is input return loss, S21 is forward transmission loss, S12 is reverse transmission loss, and S22 is output return loss.
5. Click  at the top of the screen to add markers.

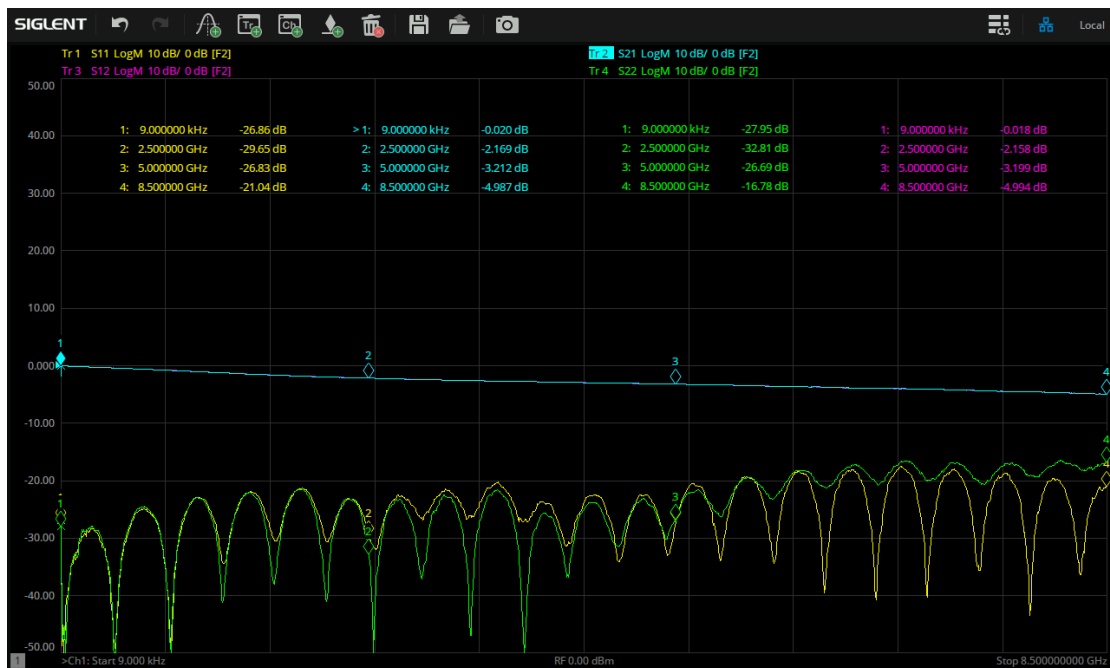

Figure 4-12 Test result of long through line

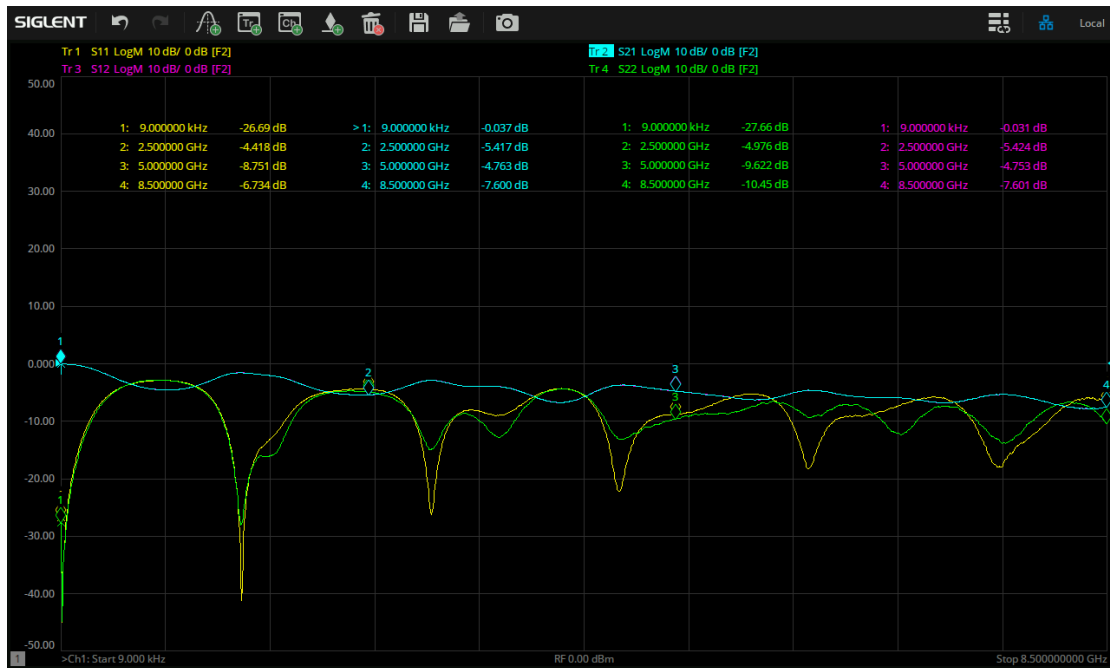

Figure 4-13 Test result of impedance transformation line

TDR Test :

1. If the VNA is equipped with TDR option, the transformation curve of impedance with distance can be observed.
2. Click **Math** > **TDR** > **On** to enter TDR mode.
3. After entering TDR mode, the system will automatically pop up the TDR Setup Wizard. Users can also click **Setup** > **Setup Wizard...** on the bottom toolbar to enter.
 - In the Overview window, select Deskew calibration.
 - In the DUT Topology window, select Single Ended 1-Port.
 - In the Deskew window, make the cable open at the terminal and then click **Deskew**.
 - In the DUT Length window, connect the through line or impedance transformation line, and then click **Measure** to automatically measure the DUT length.
 - The Rise Time window does not require any operation.
4. In the toolbar at the bottom of TDR, click **Setup** > **Dielectric Const.**, input 3.48 as the dielectric constant.
5. Double click to enlarge the trace window of T11, making it easier to observe the trend of impedance variation with distance. In the toolbar at the bottom of TDR, click **TDR/TDT** > **Scale** to adjust X and Y axes.

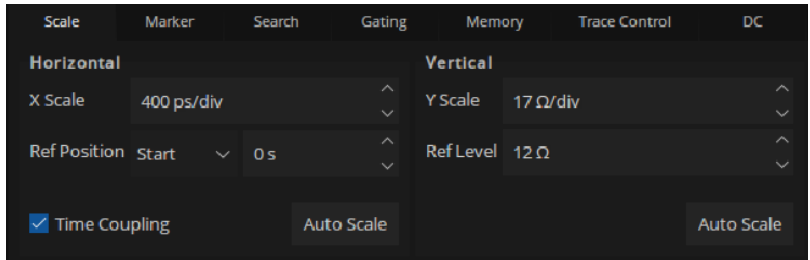



Figure 4-14 TDR axes scale adjustment

- Click  at the top of the screen to add markers.

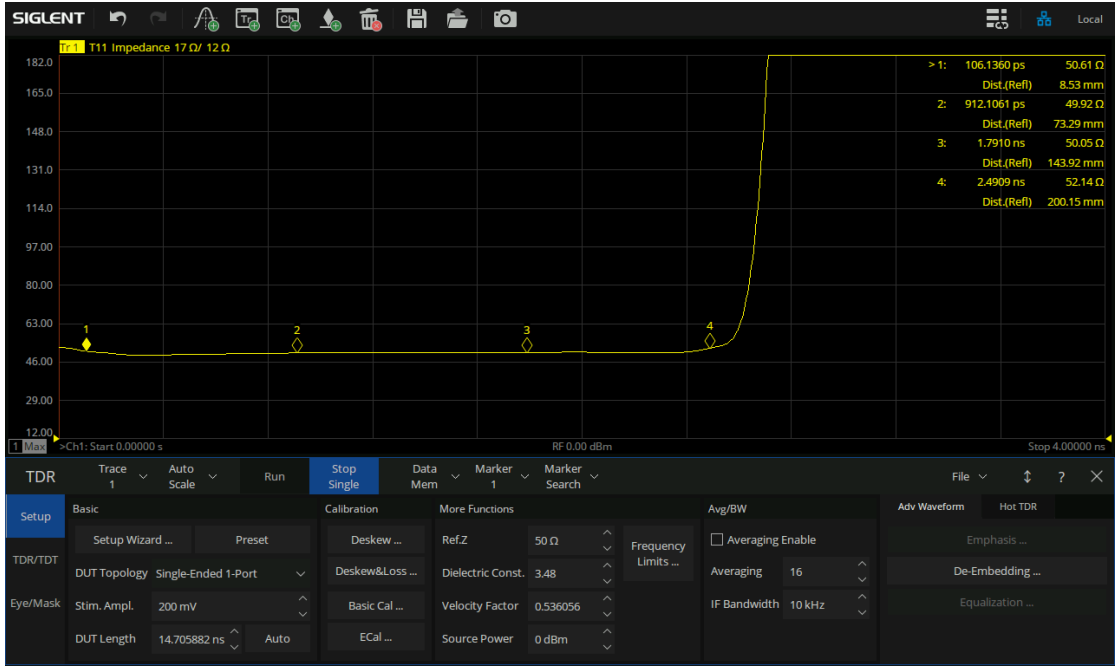



Figure 4-15 TDR test result of long through line



Figure 4-16 TDR test result of impedance transformation line

4.3.8 Differential Line and Differential Impedance Transformation Line

Mixed S-parameter Test :

1. Preheat the VNA, set basic parameters such as frequency range and number of points, and perform full four port calibration.
2. Click **Meas** > **Balanced** > **Topology...** , select **BAL-BAL** , and set the appropriate connection topology. Ports 1 and 2 correspond to the two ports on one side of the differential line or differential impedance transformation line, while ports 3 and 4 correspond to the two ports on the other side of the line.
3. Connect the differential line or differential impedance transformation line to the VNA by cables according to the connection topology in the previous step.
4. Click  at the top of the screen to add three measurement traces.
5. Click **Meas** > **Balanced** > **Other...** and set the three traces as Sdd11, Sdd21, and Sdd22. Among them, Sdd11 is input differential return loss, Sdd21 is differential insertion loss, and Sdd22 is output differential return loss.
6. Click  at the top of the screen to add markers.

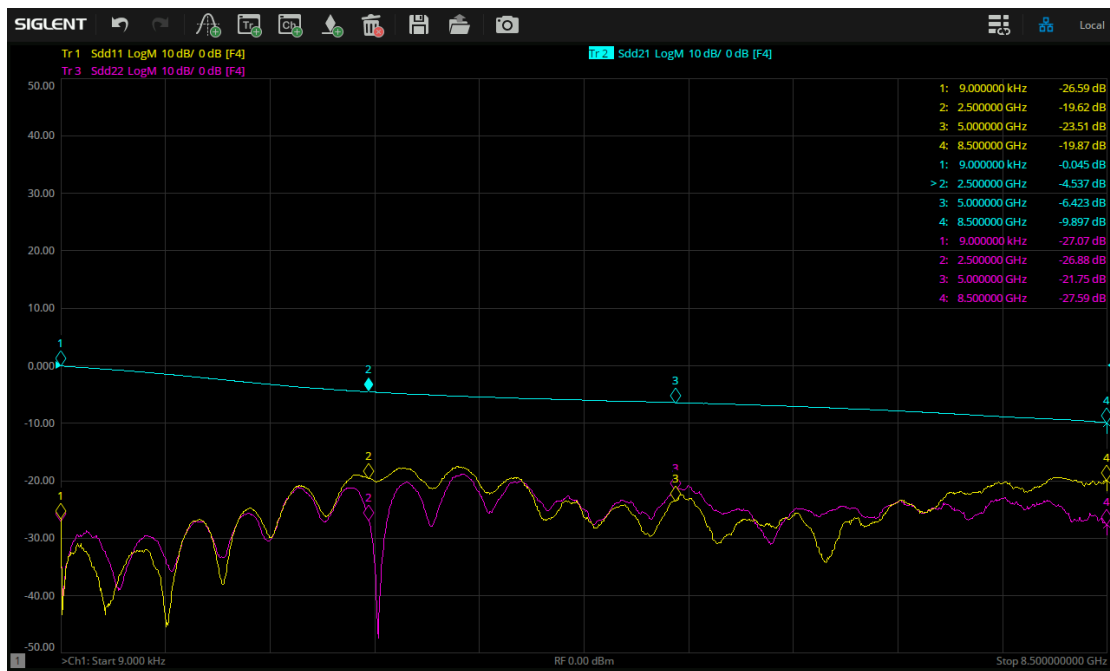

Figure 4-17 Test result of differential line



Figure 4-18 Test result of differential impedance transformation line

7. If a 2-port vector network analyzer is used, only differential return loss can be tested. Connect port 1 and port 2 to the same side of the differential line or differential impedance transformation line, follow the above steps, set port topology to BAL and check Sdd11 and Sdd22. During the test, 50 Ω loads need to be connected to the unconnected ports of the differential line or differential impedance transformation line.

TDR Test :

1. If the VNA is equipped with TDR option, the transformation curve of differential impedance with distance can be observed.
2. Click **Math** > **TDR** > **On** to enter TDR mode.
3. After entering TDR mode, the system will automatically pop up the TDR Setup Wizard. Users can also click **Setup** > **Setup Wizard...** on the bottom toolbar to enter.
 - In the Overview window, select Deskew calibration.
 - In the DUT Topology window, select Differential 1-Port.
 - In the Deskew window, make the cables open at the terminal and then click **Deskew**.
 - In the DUT Length window, connect cables to the differential line or differential impedance transformation line, and then click **Measure** to automatically measure the DUT length.
 - The Rise Time window does not require any operation.
4. In the toolbar at the bottom of TDR, click **Setup** > **Dielectric Const.**, input 3.48 as the dielectric constant.
5. Double click to enlarge the trace window of Tdd11, making it easier to observe the trend of

differential impedance variation with distance. In the toolbar at the bottom of TDR, click **TDR/TDT** > **Scale** to adjust X and Y axes.

6. Click  at the top of the screen to add markers.

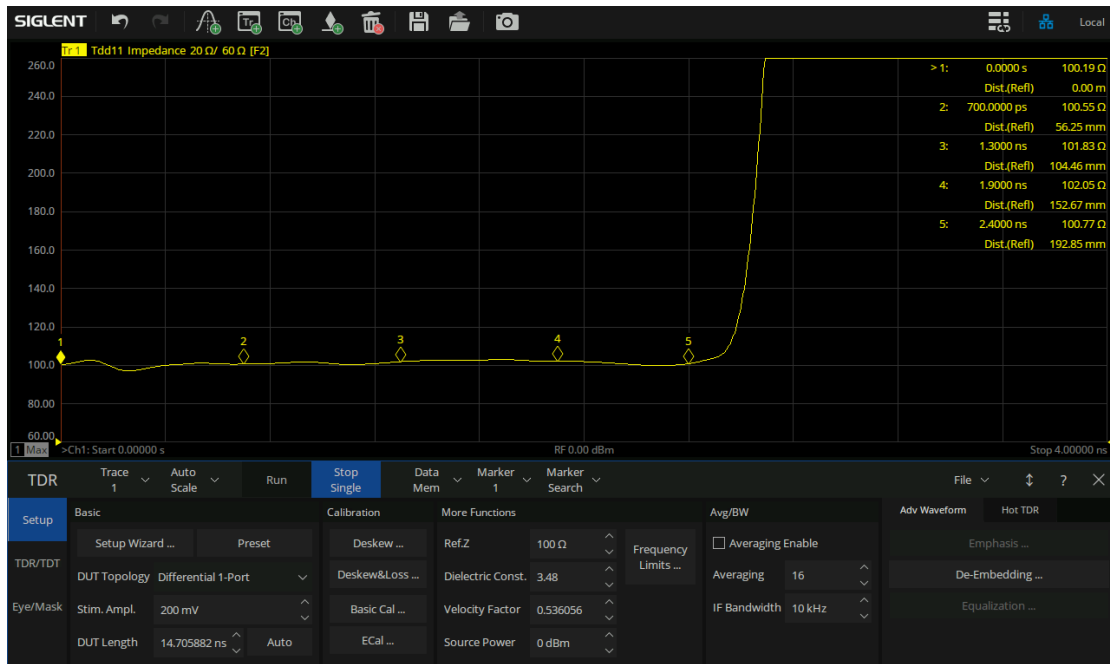

Figure 4-19 TDR test result of differential line



Figure 4-20 TDR test result of differential impedance transformation line

Headquarters:

SIGLENT Technologies Co., Ltd
Add: Bldg No.4 & No.5, Antongda Industrial
Zone, 3rd Liuxian Road, Bao'an District,
Shenzhen, 518101, China
Tel: + 86 755 3688 7876
Fax: + 86 755 3359 1582
Email: sales@siglent.com
Website: int.siglent.com

North America:

SIGLENT Technologies America, Inc
6557 Cochran Rd Solon, Ohio 44139
Tel: 440-398-5800
Toll Free: 877-515-5551
Fax: 440-399-1211
Email: info@siglentna.com
Website: www.siglentna.com

Europe:

SIGLENT Technologies Germany GmbH
Add: Staetzlinger Str. 70
86165 Augsburg, Germany
Tel: +49(0)-821-666 0 111 0
Fax: +49(0)-821-666 0 111 22
Email: info-eu@siglent.com
Website: www.siglenteu.com

Follow us on
Facebook: SiglentTech

