

# SDM4055A

## Digital Multimeter

QuickStart  
EN01A





# Copyright Information

## Declaration

SIGLENT products are protected by patent law in and outside of P.R.C.

**SIGLENT** reserves the right to modify or change parts of or all the specifications or pricing policies at the company's sole decision.

Information in this publication replaces all previously corresponding material.

Any method of copying, extracting, or translating the contents of this manual is not allowed without the permission of **SIGLENT**.

**Note:** **SIGLENT** is the registered trademark of SIGLENT TECHNOLOGIES CO., LTD.

# Contents

Copyright Information .....	1
General Safety Summary .....	3
Safety Terms and Symbols .....	4
Allgemeine Sicherheits ü bersicht.....	5
Sicherheitsbegriffe und symbole.....	6
Mechanical Dimensions.....	7
Panel Introduction.....	8
Preparation Before Use .....	10
User Interface .....	12
Basic Operations .....	13
Troubleshooting.....	16
More Information .....	16

## **General Safety Summary**

Carefully read the following safety precautions to avoid any personal injury or damage to the instrument and any products connected to it. To avoid potential hazards, please use the instrument as specified.

### **Use the Proper Power Cord**

### **Ground the Instrument**

The instrument is grounded through the protective earth conductor of the power cord. To avoid electric shock, please make certain the instrument is grounded correctly before connecting its input or output terminals.

### **Connect the Signal Cable Correctly**

The potential of the signal cable ground is float to the earth ground. Do not touch the signal wire while connected to high voltage.

### **Look Over All Terminal Ratings**

### **Do not operate with suspected failures**

### **Avoid Exposed Circuits and Components**

### **Do Not Operate Without Covers**

### **Use Only the Specified Fuse**

### **Use Proper Overvoltage Protection**

### **Antistatic Protection**

### **Keep Good Ventilation**

### **Only Qualified Technical Personnel Can Perform Maintenance Procedures**

### **Do Not Operate in Wet or Damp Conditions**

### **Do Not Operate in Flammable or Explosive Environment.**

### **Keep the Surface of the Instrument Clean and Dry**

### **Prevent Fire or Personal Injury**

**The Disturbance Test of All the models Meets the Limit Values of A in the Standard of EN 61326-1:2013**

## Safety Terms and Symbols

**Terms in this manual.** Terms may appear in this manual:

**WARNING:** Warning statements indicate the conditions and behaviors that could result in injury or loss of life.

**CAUTION:** Caution statements indicate the conditions and behaviors that could result in damage to this product or other properties.

**CAT II (300V):** IEC Measurement Category II. Inputs may be connected to mains (up to 300VAC) under Category II overvoltage conditions.

**Terms used on the instrument.** Terms may appear on the instrument:

**DANGER** indicates an injury or hazard that may immediately happen.

**WARNING** indicates an injury or hazard that may not immediately happen.

**CAUTION** indicates that a potential damage to the instrument or other property might occur.

**Symbols used on the instrument.** Symbols may appear on the instrument:



Hazardous  
Voltage



Warning



Protective  
Earth Ground



Test Ground



Chassis  
Ground

## **Allgemeine Sicherheitsübersicht**

Lesen Sie die folgenden Sicherheitshinweise sorgfältig durch, um Verletzungen oder Schäden am Gerät und an den daran angeschlossenen Produkten zu vermeiden. Um mögliche Gefahren zu vermeiden, verwenden Sie das Gerät bitte wie angegeben.

### **Verwenden Sie ein geeignetes Netzkabel**

#### **Erden Sie das Gerät**

Das Gerät ist über den Schutzleiter der Netzleitung geerdet. Um einen elektrischen Schlag zu vermeiden, vergewissern Sie sich bitte, dass das Gerät korrekt geerdet ist, bevor Sie die Eingangs- oder Ausgangsklemmen des Geräts anschließen.

#### **Schließen Sie das Messkabel richtig an**

Das Potential des Signalkabels unterscheidet sich von dem der Erde. Berühren Sie das Signalkabel nicht, wenn es mit einem Hochspannungskabel verbunden ist.

#### **Überprüfen Sie die Nennwerte aller Klemmen**

#### **Betreiben Sie das Gerät nicht bei vermuteten Defekten**

#### **Vermeiden Sie freiliegende Schaltkreise oder Komponenten**

#### **Nicht ohne Abdeckungen arbeiten**

#### **Nur die angegebene Sicherung verwenden**

#### **Verwenden Sie den richtigen Überspannungsschutz**

#### **Schutz vor Elektrostatik**

#### **Für gute Belüftung sorgen**

#### **Nur qualifiziertes technisches Personal kann Wartungsmaßnahmen durchführen**

#### **Nicht in feuchter Umgebung betreiben**

#### **Betreiben Sie das Gerät nicht in explosionsgefährdeten Umgebungen**

#### **Halten Sie die Produktoberflächen sauber und trocken**

#### **Verhindern Sie Feuer oder Personenschäden**

#### **Der Störtest aller Modelle erfüllt die Grenzwerte von A in der Norm EN 61326-1:2013**

## Sicherheitsbegriffe und symbole

**Begriffe in diesem Handbuch.** Diese Begriffe können in diesem Handbuch vorkommen:

**WARNUNG** Warnhinweise weisen auf Bedingungen oder Praktiken hin, die zu Verletzungen oder zum Verlust des Lebens führen können.

**VORSICHT** Vorsichtshinweise weisen auf Bedingungen oder Praktiken hin, die zu Schäden an diesem Produkt oder anderen Gegenständen führen können.

**CAT II (300V):** IEC Messkategorie II. Die Eingänge können unter Überspannungsbedingungen der Kategorie II an das Netz (bis 300VAC) angeschlossen werden.

**Begriffe auf dem Produkt.** Diese Begriffe können auf dem Produkt erscheinen:

**DANGER** Weist auf direkte Verletzungen oder Gefahren hin, die auftreten können.

**WARNING** Weist auf mögliche Verletzungen oder Gefährdungen hin, die auftreten können.

**CAUTION** Weist auf mögliche Schäden am Gerät oder an anderen Gegenständen hin, die eintreten können.

**Symbole auf dem Produkt.** Diese Symbole können auf dem Produkt erscheinen:



Hazardous  
Voltage



Warning



Protective  
Earth Ground



Test Ground



Chassis  
Ground



# Mechanical Dimensions

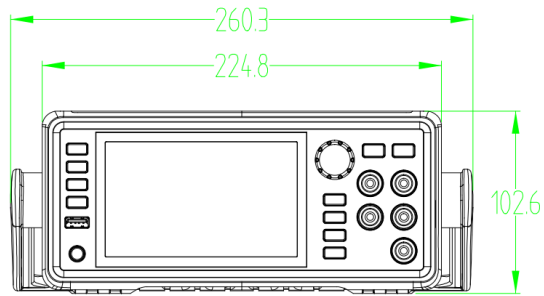

Front View

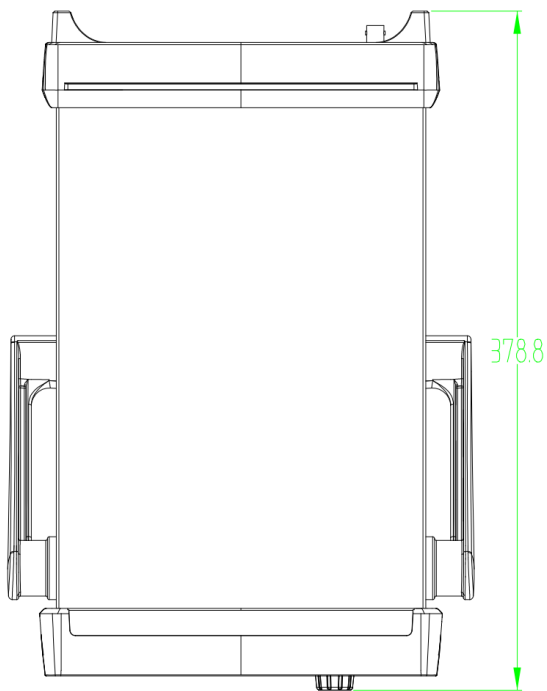

Top View

## Panel Introduction



### Front Panel

1. **Power Key** Short/long press the key to turn on/off the instrument.
2. **USB Host** By using this interface, you can store the current state or measurement data into USB storage device, and you can also read the state files or updated firmware from USB storage device.
3. **Menu Operation Buttons** Press any softkey to activate the corresponding menu.
4. **Touchable Display Screen** Display the menu and measurement parameter settings for the current function, system status, and prompt messages. Related operations can be achieved by touching the screen area with fingers.
5. **Knob**
6. **Trigger and Measurement Function Buttons**
7. **Left/Right Directional Buttons** Move the cursor, with the same function as counterclockwise/clockwise rotation of the knob.
8. **Signal Input Terminals** The measured signal (device) will be connected into the multimeter through these terminals. Different measurement functions have different connections methods. For details, please refer to “Measurement Connections”.



### Rear Panel

1. **Power Socket** The multimeter accepts two types of AC supplies. Please use the power cord provided in the accessories to connect the multimeter to the AC power through this socket.  
**Note:** A proper voltage scale must be first selected (through the AC Voltage Selector) before power connection.
2. **Power Fuse**
3. **AC Voltage Selector** Select a proper voltage scale (110 V or 220 V) according to the AC supply used.
4. **USB Host**
5. **USB Device** Connect the PC through this interface. You can use SCPI commands or PC software to control SDM4055A remotely.
6. **LAN** Through this interface, the multimeter can be connected to the network for remote control.
7. **VMC Output** The multimeter outputs a 5V pulse from this port every time it completes a sampling.
8. **Ext Trigger** Trigger the multimeter by connecting a trigger pulse through the [EXT TRIG] connector. Note the external trigger source must be selected.
9. **Instrument Lock Hole** You can use the safety lock (please purchase it yourself) to lock the multimeter in a fixed place if necessary.

## Menu Operation Buttons

- Home** Set measurement functions and corresponding parameters related to the functions.
- Menu** Select or set parameters about Utility, Math, Acquire, Display, Dual Function, Probe Hold and Help.
- Utility** Set the system functions about Store/Recall, File Management, I/O Config, Test Management, System Setting and Date Time Edit.
- Help** Provide help information.

## Knob

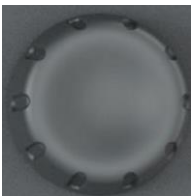

Rotate the knob clockwise/counterclockwise to move the cursor, press down to select the menu item where the cursor is located or turn on/off the menu item function.

## Trigger and Measurement Functions Buttons

- Single** Single Trigger.
- Run/Stop** Auto Run/Stop.
- Acquire** Set up functions such as Acquire, Trigger Setting, VMC Out, and Save Readings.
- Function** Open the measurement function selection menu to select the following measurement functions:

<b>DCV</b>	DC voltage measurement	<b>Freq</b>	Frequency measurement
<b>ACV</b>	AC voltage measurement	<b>) Cont</b>	Continuity measurement
<b>DCI</b>	DC current measurement	<b>-&gt;+</b>	Diode measurement
<b>ACI</b>	AC current measurement	<b>Temp</b>	Temperature measurement
<b>Ω2W</b>	2-wire resistance measurement	<b>Sensor</b>	Sensor measurement
<b>Ω4W</b>	4-wire resistance measurement	<b>Period</b>	Period measurement
<b>-  -</b>	Capacitance measurement		

## Preparation Before Use

### To Adjust the Handle

Please grip the handle by the two sides and pull it outward to adjust the handle position of SDM4055A. Then rotate the handle to the appropriate position. Please operate as the following figure:

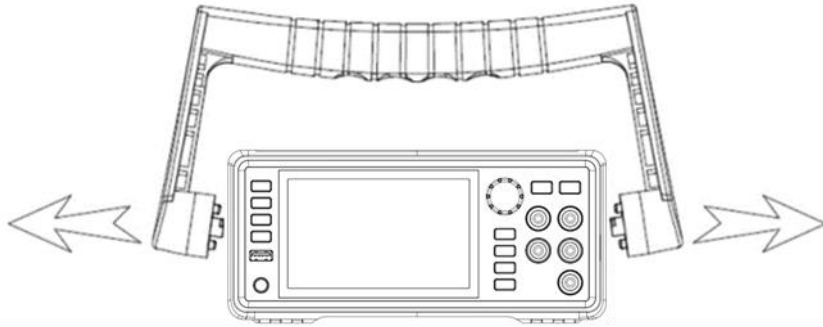

Handle Adjustment

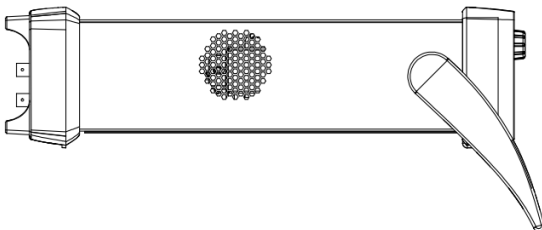
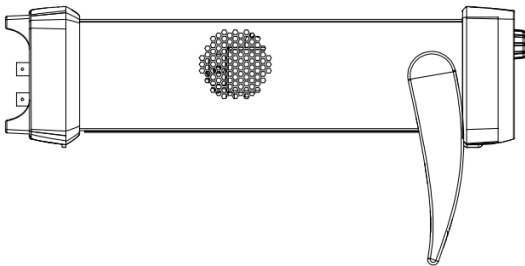
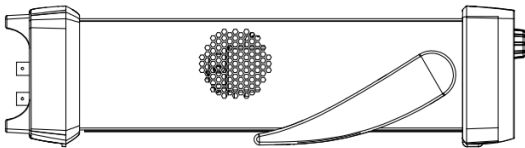

Viewing Position

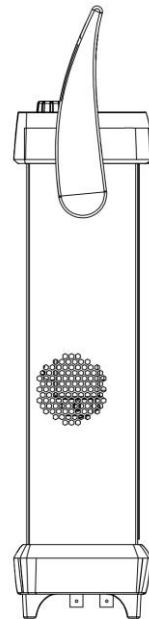

Carrying Position

## Start the Multimeter

Before connect the instrument to a power source, please select the AC voltage in the AC voltage selector on the rear panel of your multimeter according to the power supply. Then connect the power cord as shown in the following figure.

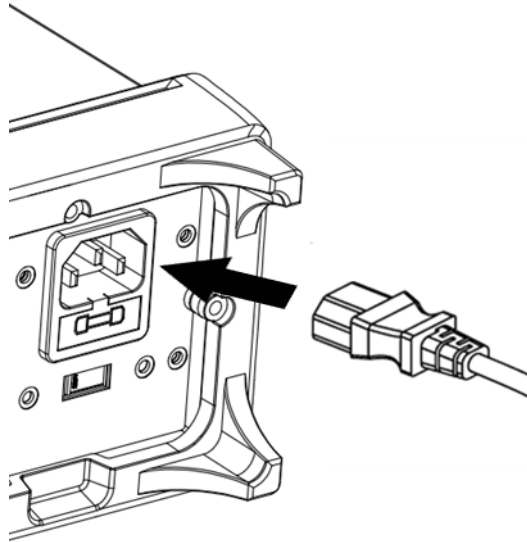

Connect Power Cord

Press the power key on the front panel to start up the multimeter. If the multimeter does not start normally, please refer to the relevant content and steps of the Troubleshooting for inspection.

# User Interface

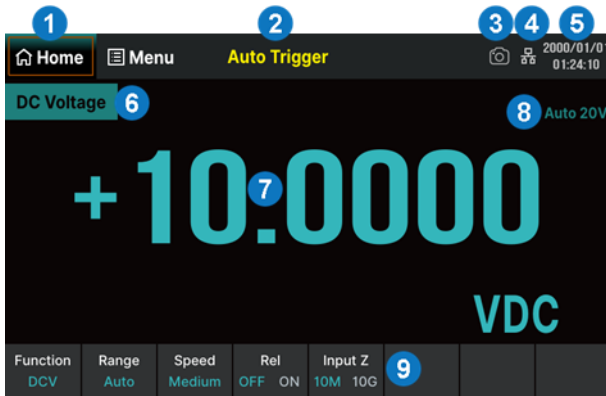

## Home Interface

1. Home. Functionally equivalent to the "Home" button on the left side of the front panel
2. Trigger mode
3. Quick screenshot identification
4. LAN status icon
5. Date and time display area
6. Measurement function
7. Measurement result
8. Current range in use
9. Operation menu. Select the measurement function and set the parameters for this function

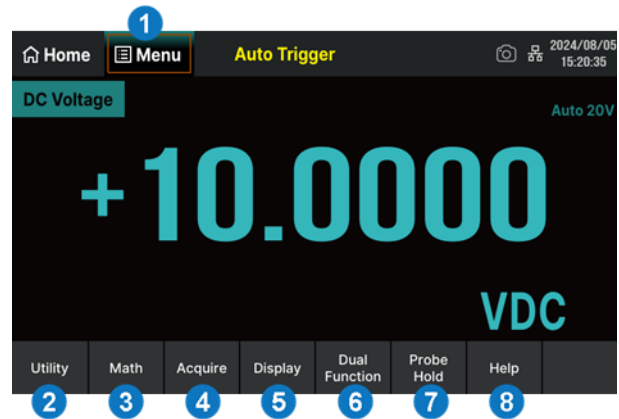

## Menu Interface

1. Menu. Functionally equivalent to the "Menu" button on the left side of the front panel
2. Utility. Set up functions about system settings. Functionally equivalent to the "Utility" button on the left side of the front panel
3. Math. Enable or disable Statistics, Limits, dB/dBm, and Rel Value functions
4. Acquire. Set trigger mode (Continue / Data Log), Trigger Setting, VMC Out, and Save Readings
5. Display. Set the display mode to Numbers / Bar / Trend / Histogram
6. Dual Function. Synchronously display two kinds of characteristics of the same signal
7. Probe Hold. Up to 8 of the latest measured readings can be displayed simultaneously
8. Help. Built in help system for convenient viewing of help information

## Measurement Function

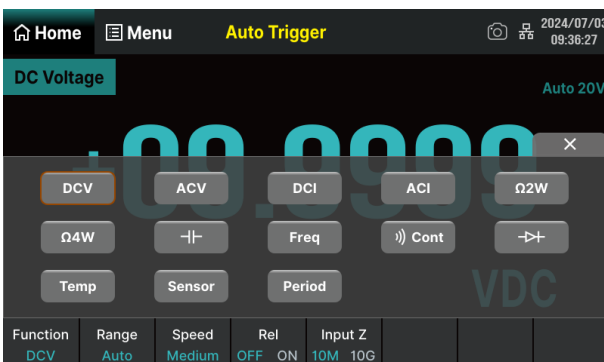

Click on the "Function" menu at the bottom left of the home interface, or click on the "Function" button on the front panel to enter the measurement function selection interface (as shown in the left figure). According to the measurement requirements, touch or use the knob to select the function buttons on the interface and set the relevant parameters for that function.

## Data Log Function

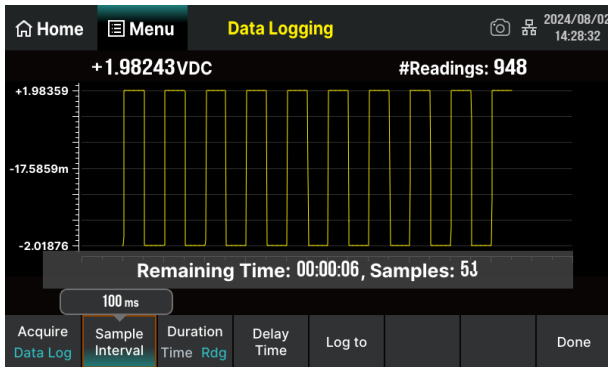

The Data Log function supports recording of AC/DC voltage, AC/DC current, resistance, capacitance, frequency, period, and temperature data. The interval time can be set within the range of 0.1s~3600s. When logging to Memory, the maximum number of readings is 2M; When logging to the File(s), the maximum number of readings is 360M. Up to 100 hours of logging time.

## Basic Operations

### Measurement Connections

The multimeter is designed with many measurement functions. After selecting the desired measurement function, please connect the signal (device) under test to the multimeter according to the method below. Do not discretionarily switch the measurement function when measuring as it may cause damage to the multimeter. For example, when the test leads are connected to the related current terminals, AC voltage measurement should not be taken.

**DCV Measurement (DCV)**

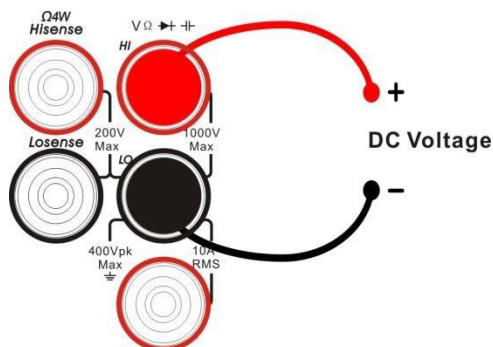

**ACV Measurement (ACV)**

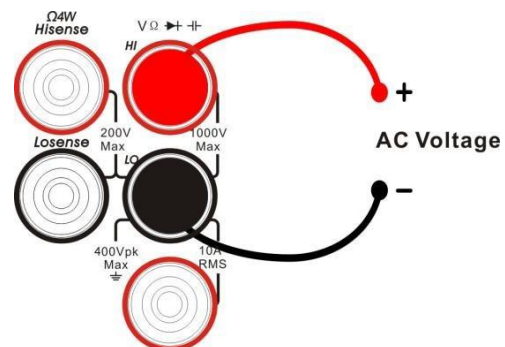

**DCI Measurement (DCI)**

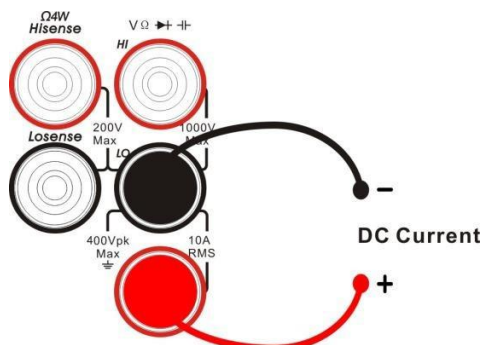

**ACI Measurement (ACI)**

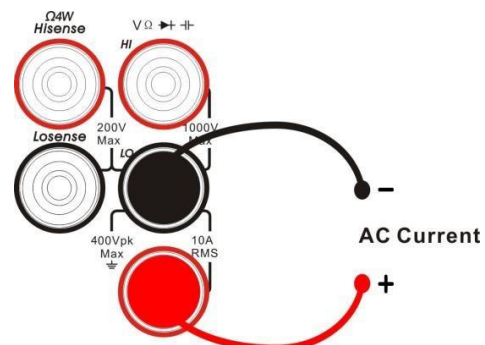

### Resistance Measurement (2WR)

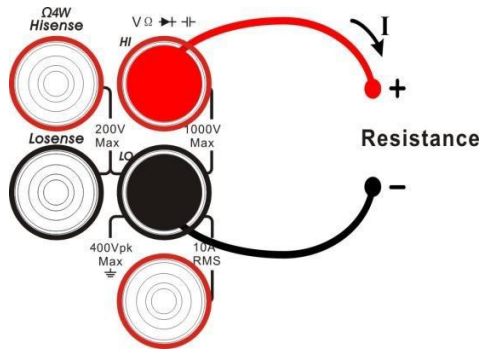

### Resistance Measurement (4WR)

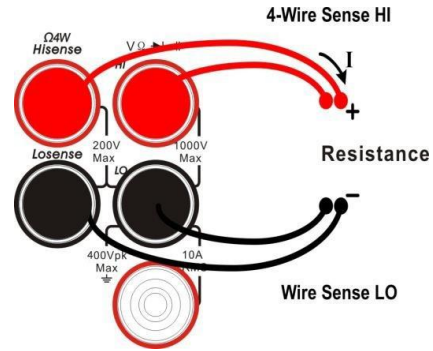

### Capacitance Measurement (Cap)

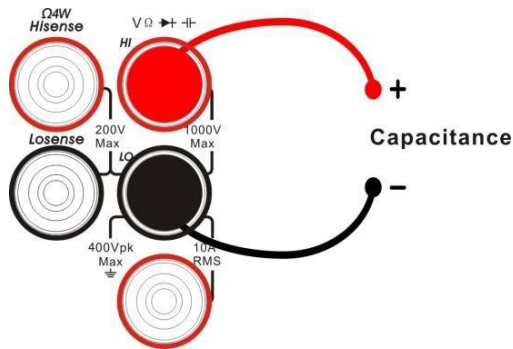

### Frequency/Period Measurement (Freq/Period)

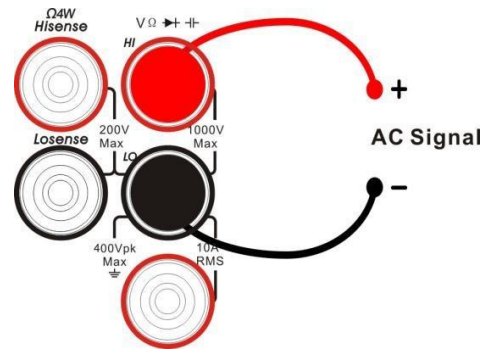

### Continuity Measurement (Cont)

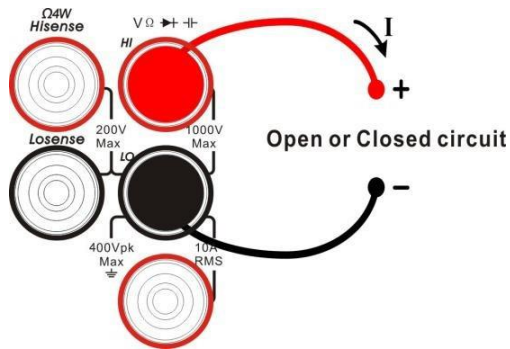

### Diode Measurement (Diode)

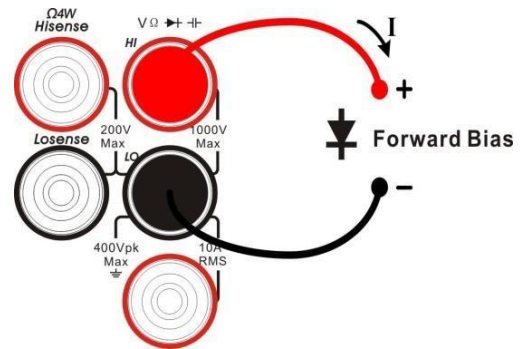

### Temperature Measurement (Temp) (For RTD and thermocouple sensors)

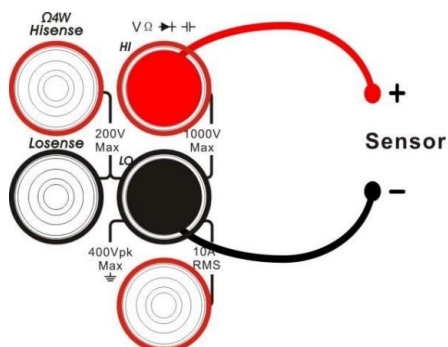



## To Use the Built-in Help System

To obtain built-in help information of the product, please press [Help] to enter help system, then choose the help item you want and view the corresponding help information.

The built-in help information is listed as the following:

- 1) Basic measurement
- 2) Math function
- 3) Dual display function
- 4) Save and recall
- 5) Teach support

## Replace the Power Fuse

The multimeter is already installed with a power fuse before leaving factory. This fuse is a slow melting, explosion-proof, T315mA, 5x20mm fuse. If you need to replace the fuse, please follow the steps below to replace it:

- 1) Turn off the multimeter and remove the power cord.
- 2) Press down the block tongue using a straight screwdriver (in the direction of the dotted arrow in the figure) and pull out of the fuse seat.
- 3) Select a proper voltage scale.
- 4) Replace a specified fuse.
- 5) Reinstall the fuse seat into the slot.

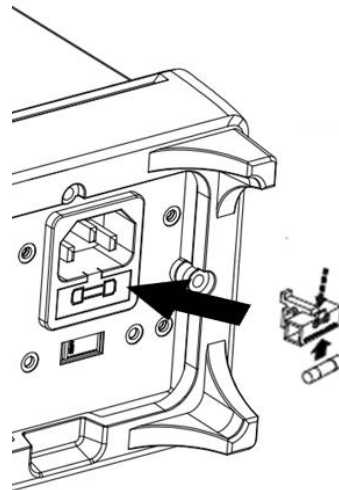

Replace the Power Fuse

## Troubleshooting

The commonly encountered failures and their solutions are listed below. When you encounter those problems, please solve them following the corresponding steps. If the problem remains still, please contact **SIGLENT** and provide your device information.

1. If the screen is still dark with nothing displayed after pressing the power key.
  - 1) Check whether the power cord is well connected.
  - 2) Check if the power switch on the front panel is pressed firmly.
  - 3) Check whether the power fuse is burned out. If the fuse needs to be changed, please use the specified fuse.
  - 4) Restart the instrument after finishing the above inspections.
  - 5) If the instrument still can't start up properly, please contact **SIGLENT**.
2. The reading doesn't change when a current signal is input.
  - 1) Check whether the test lead is correctly inserted into the HI and LO terminals of current measurement.
  - 2) Check whether the DCI or ACI measurement function is enabled.
  - 3) Check whether the DCI measurement function is used to measure AC current.
3. The reading is abnormal when a voltage signal is input.
  - 1) Check whether the test lead is correctly inserted into the HI and LO terminals of voltage measurement.
  - 2) Check whether the DCV or ACV measurement function is enabled.
  - 3) Check whether the DCV measurement function is used to measure AC voltage.
4. The USB storage device cannot be identified.
  - 1) Check whether the USB storage device is in good condition.
  - 2) Make sure the USB storage device you used is a flash storage device. This instrument does not support hardware storage type.
  - 3) Restart the instrument and then insert the USB storage device.
  - 4) If the problem persists, please contact **SIGLENT**.

## More Information

You can obtain the instrument information and installation status of all options in “system setup” under the Utility menu. For more information of this product, please refer to the following manuals (you can also download them from the SIGLENT web site: <http://int.siglent.com>):

- **SDM4055A user manual:**

Provides detailed introductions of the functions of this instrument.

- **SDM4055A data sheet:**

Provides the main characteristics and specifications of this instrument.

- **SDM4000A programming manual:**

Provides detailed introductions of the SCPI commands and programming of this instrument.



**Headquarters:**

SIGLENT Technologies Co., Ltd  
Add: Bldg No.4 & No.5, Antongda Industrial  
Zone, 3rd Liuxian Road, Bao'an District,  
Shenzhen, 518101, China  
Tel: + 86 755 3688 7876  
Fax: + 86 755 3359 1582  
Email: sales@siglent.com  
Website: int.siglent.com

**North America:**

SIGLENT Technologies America, Inc  
6557 Cochran Rd Solon, Ohio 44139  
Tel: 440-398-5800  
Toll Free: 877-515-5551  
Fax: 440-399-1211  
Email: info@siglentna.com  
Website: www.siglentna.com

**Europe:**

SIGLENT Technologies Germany GmbH  
Add: Staetzlinger Str. 70  
86165 Augsburg, Germany  
Tel: +49(0)-821-666 0 111 0  
Fax: +49(0)-821-666 0 111 22  
Email: info-eu@siglent.com  
Website: www.siglenteu.com

Follow us on  
Facebook: SiglentTech

